

Part number:

096-10246a

HYDROMA

HYDRAULICKÉ SYSTÉMY

**HIDROMA
SYSTEMS**

UKŁADY HYDRAULICZNE

HYDROMA

ГИДРАВЛИЧЕСКИЕ СИСТЕМЫ

64 300/107 ED



ERS4M

FLOW RESTRICTOR VALVE

SERIES 40

MODULAR VERSION
ISO 4401-05 (CETOP 05)

p max 320 bar
Q max (see table of performances)

MOUNTING INTERFACE

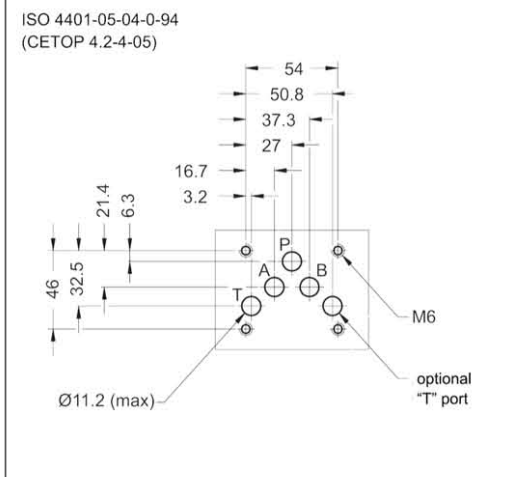

OPERATING PRINCIPLE

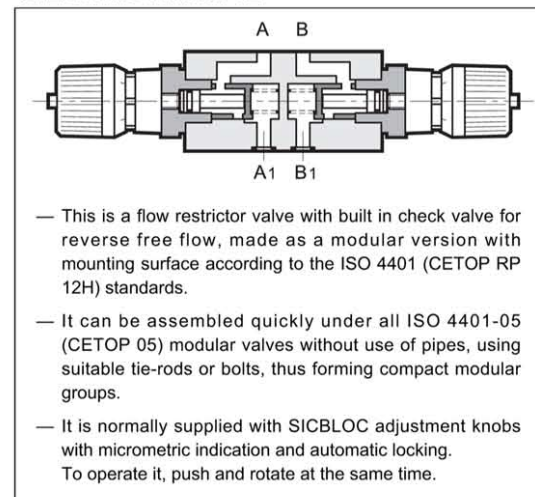

CONFIGURATIONS (see Hydraulic symbols table)

- Configuration "SA": used when control of the flow exiting from the actuator on line A is desired.
- Configuration "SB": used when control of the flow exiting from the actuator on line B is desired.
- Configuration "D": independently controls the flow exiting from the two chambers of the actuator.
- Configuration "RD": independently controls the flow entering the two chambers of the actuator.
- All the configurations have a built-in check valve that allows reverse free flow (cracking pressure of 0,5 bar).

PERFORMANCES (measured with mineral oil of viscosity 36 cSt at 50°C)

Maximum operating pressure	bar	320
Check valve cracking pressure		0,5
Maximum flow rate in the controlled lines	l/min	80
Maximum flow rate in the free lines		100
Ambient temperature range	°C	-20 / +50
Fluid temperature range	°C	-20 / +80
Fluid viscosity range	cSt	10 ÷ 400
Fluid contamination degree	According to ISO 4406:1999 class 20/18/15	
Recommended viscosity	cSt	25
Mass:	kg	3,1

HYDRAULIC SYMBOLS

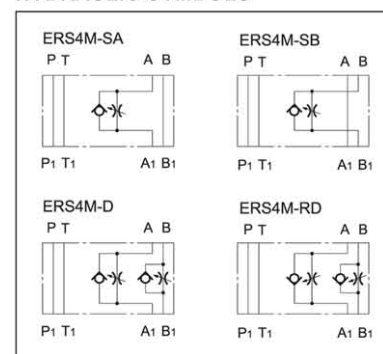

Part number:

096-10246b

HYDROMA

HYDRAULICKÉ SYSTÉMY

**HIDROMA
SISTEMS**

UKŁADY HYDRAULICZNE

HYDROMA

ГИДРАВЛИЧЕСКИЕ СИСТЕМЫ

ERS4M

SERIES 40

1 - IDENTIFICATION CODE

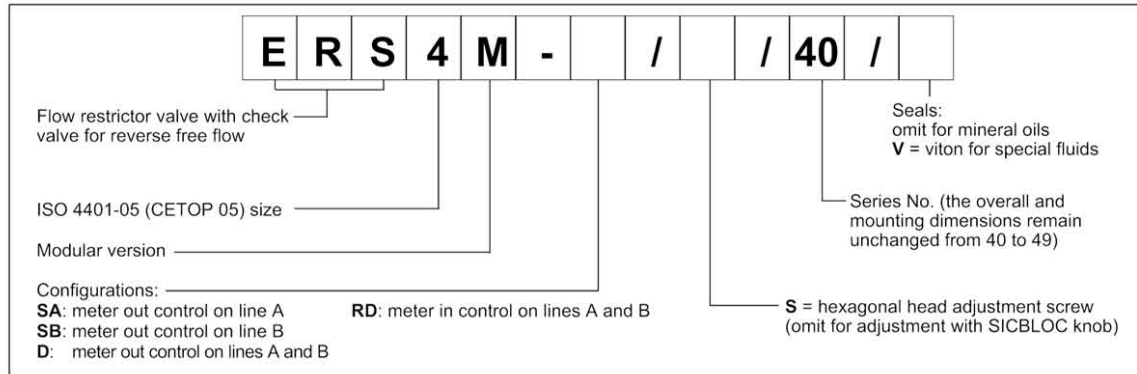

2 - CHARACTERISTIC CURVES (values obtained with viscosity of 36 cSt at 50°C)

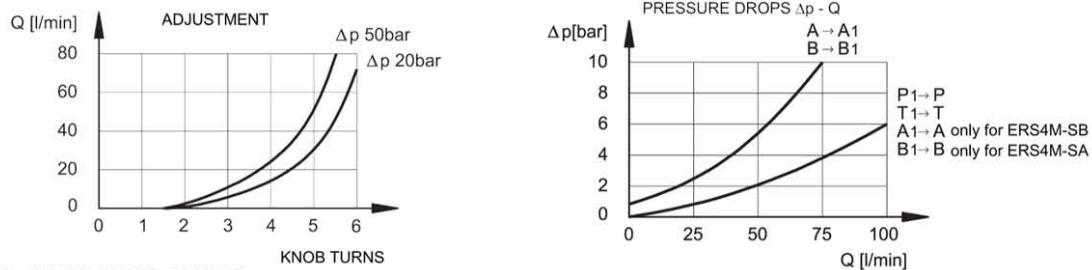

3 - HYDRAULIC FLUIDS

Use mineral oil-based hydraulic fluids HL or HM type, according to ISO 6743-4. For these fluids, use NBR seals. For fluids HFDR type (phosphate esters) use FPM seals (code V). For the use of other kinds of fluid such as HFA, HFB, HFC, please consult our technical department. Using fluids at temperatures higher than 80 °C causes a faster degradation of the fluid and of the seals characteristics. The fluid must be preserved in its physical and chemical characteristics.

4 - OVERALL AND MOUNTING DIMENSIONS

