

Part number:

074-10662

HYDROMA

HYDRAULICKÉ SYSTÉMY

**HIDROMA
SYSTEMS**

UKŁADY HYDRAULICZNE

HYDROMA

ГИДРАВЛИЧЕСКИЕ СИСТЕМЫ

• **Materials**

Carbon Steel EN-10277-3

Seals: NBR

Back-Up-Ring: PTFE

Balls: AISI 1010/1015

Springs: Carbon Steel
DIN 17233/84(B)

• **Applications:** Designed for Oil hydraulic Applications according to European Directive 97.23.EC

• **Equivalence**

FASTER PV 9 CPV

ARGUS SVK

PARKER 4200

• **Working temperature (Seals)**

	NBR	Viton	EPDM
	+100°C	+200°C	+150°C
	-30°C	-10°C	-40°C

• **Sectors:** Industrial, Agricultural



MODEL STRUCTURE

Example;

107.12113 KF

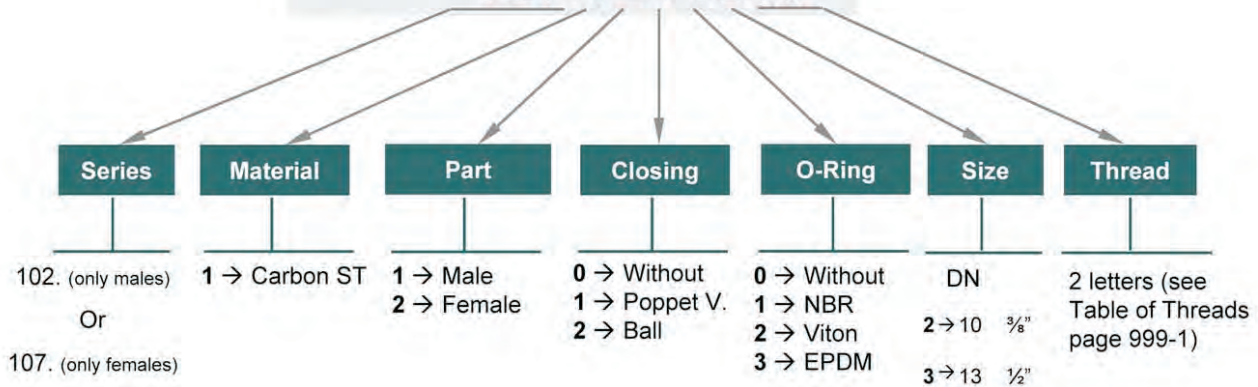

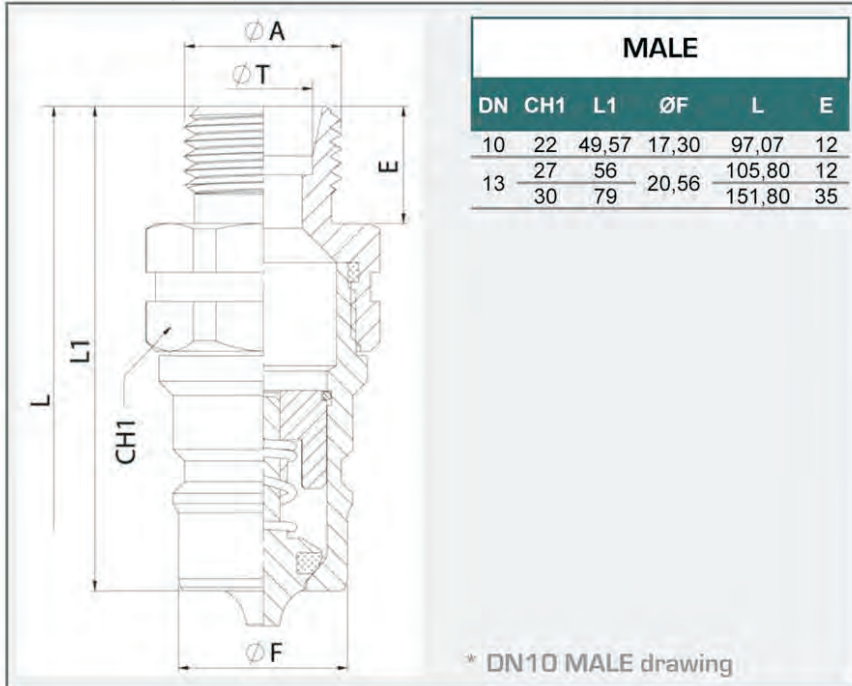

STANDARD MALE MODELS			
DN	ØA	ØT	REF.
10	M12x1,5	6L	102.11112JB
	M14x1,5	8L	102.11112JC
	M16x1,5	10L	102.11112JD
	M18x1,5	12L	102.11112JE
	M16x1,5	8S	102.11112KD
	M18x1,5	10S	102.11112KE
	M20x1,5	12S	102.11112KF
	3/8" BSP	-	102.11112AN
13	M14x1,5	8L	102.11113JC
	M16x1,5	10L	102.11113JD
	M18x1,5	12L	102.11113JE
	M22x1,5	15L	102.11113JG
	M26x1,5	18L	102.11113JI
	M18x1,5	10S	102.11113KE
	M20x1,5	12S	102.11113KF
	M22x1,5	14S	102.11113KG
	M24x1,5	16S	102.11113KH
	M30x2	20S	102.11113KJ

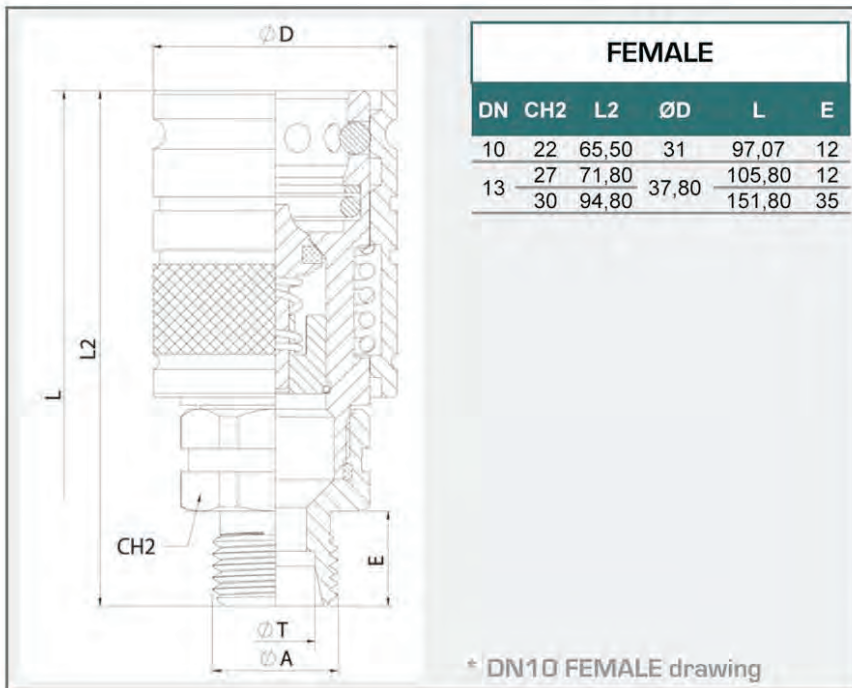

STANDARD FEMALE MODELS			
DN	ØA	ØT	REF.
10	M12x1,5	6L	107.12112JB
	M14x1,5	8L	107.12112JC
	M16x1,5	10L	107.12112JD
	M18x1,5	12L	107.12112JE
	M16x1,5	8S	107.12112KD
	M18x1,5	10S	107.12112KE
	M20x1,5	12S	107.12112KF
	3/8" BSP	-	107.12112AN
13	M14x1,5	8L	107.12113JC
	M16x1,5	10L	107.12113JD
	M18x1,5	12L	107.12113JE
	M22x1,5	15L	107.12113JG
	M26x1,5	18L	107.12113JI
	M18x1,5	10S	107.12113KE
	M20x1,5	12S	107.12113KF
	M22x1,5	14S	107.12113KG
	M24x1,5	16S	107.12113KH
	M30x2	20S	107.12113KJ

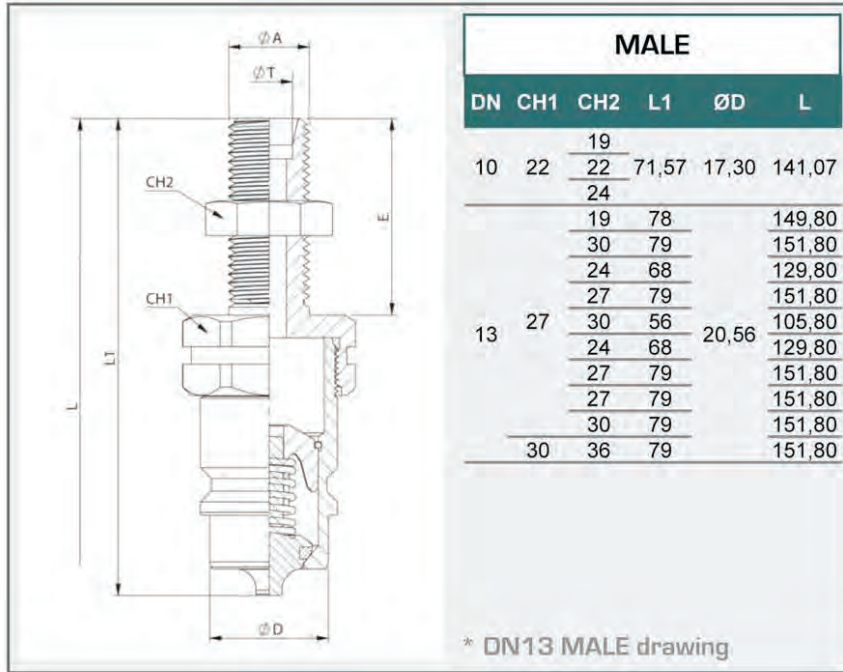

STANDARD MALE MODELS

DN	ØA	ØT	REF.
10	M12x1,5	6L	102.11112LB
	M14x1,5	8L	102.11112LC
	M16x1,5	10L	102.11112LD
	M18x1,5	12L	102.11112LE
	M16x1,5	8S	102.11112MD
	M18x1,5	10S	102.11112ME
	M20x1,5	12S	102.11112MF
13	M14x1,5	8L	102.11113LC
	M16x1,5	10L	102.11113LD
	M18x1,5	12L	102.11113LE
	M22x1,5	15L	102.11113LG
	M26x1,5	18L	102.11113LI
	M18x1,5	10S	102.11113ME
	M20x1,5	12S	102.11113MF
	M22x1,5	14S	102.11113MG
	M24x1,5	16S	102.11113MH
	M30x2	20S	102.11113MJ

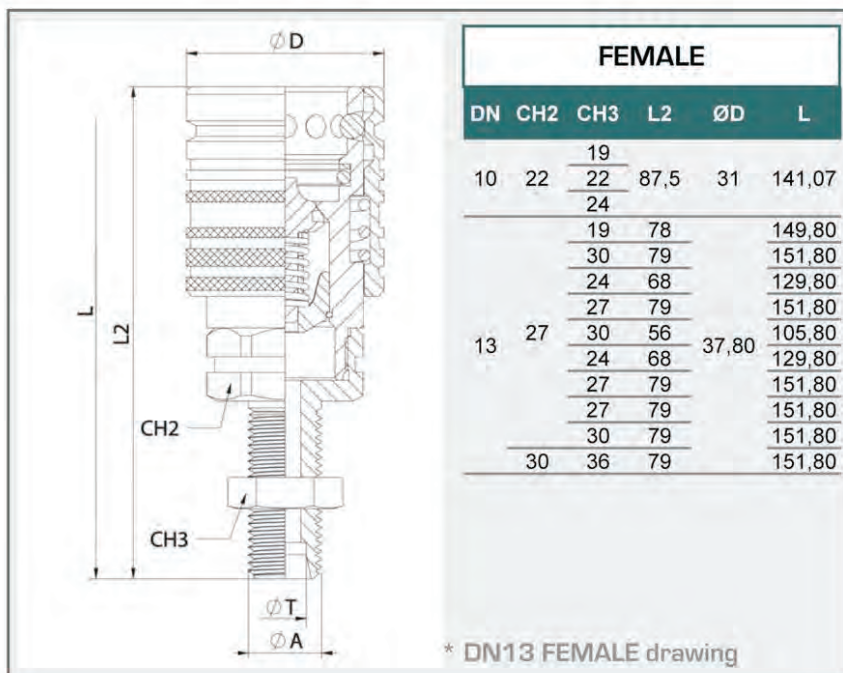

STANDARD FEMALE MODELS

DN	ØA	ØT	REF.
10	M12x1,5	6L	107.12112LB
	M14x1,5	8L	107.12112LC
	M16x1,5	10L	107.12112LD
	M18x1,5	12L	107.12112LE
	M16x1,5	8S	107.12112MD
	M18x1,5	10S	107.12112ME
	M20x1,5	12S	107.12112MF
13	M14x1,5	8L	107.12113LC
	M16x1,5	10L	107.12113LD
	M18x1,5	12L	107.12113LE
	M22x1,5	15L	107.12113LG
	M26x1,5	18L	107.12113LI
	M18x1,5	10S	107.12113ME
	M20x1,5	12S	107.12113MF
	M22x1,5	14S	107.12113MG
	M24x1,5	16S	107.12113MH
	M30x2	20S	107.12113MJ

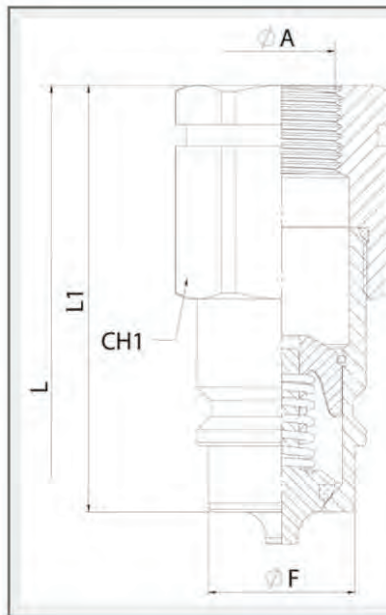

MALE					
DN	ØA	CH1	L1	ØF	L
10	1/4" BSP	22	50,57	17,30	99,07
	1/4" NPTF	22			
	3/8" BSP	22			
	3/8" NPTF	22			
	M16x1,5	22			
	M18x1,5	22			
13	3/8" BSP	27	20,56		113,80
	1/2" BSP	27			
	3/4" NPTF	30			
	M14x1,5	27			
	M16x1,5	27			
	M18,1,5	27			
	M22x1,5	27			
	3/4" -16ORB	27			
	7/8" -14ORB	27			
	* 3/4" -16ORB	27			

* DN13 MALE drawing

STANDARD MALE MODELS

DN	ØA	REF.	
10	1/4" BSP	102.11112AB	270Bar
	1/4" NPTF	102.11112BB	
	3/8" BSP	102.11112AC	
	3/8" NPTF	102.11112BC	
	M16x1,5	102.11112ND	
	M18x1,5	102.11112NE	
13	3/8" BSP	102.11113AC	250Bar
	1/2" BSP	102.11113AD	
	3/4" NPTF	102.11113BE	
	M14x1,5	102.11113NC	
	M16x1,5	102.11113ND	
	M18x1,5	102.11113NE	
	M22x1,5	102.11113NG	
	3/4" -16ORB	102.11113GF	
7/8" -14ORB	102.11113GH		
	* 3/4" -16ORB	102.11113GFA	

* This reference is habitually provided in the Spanish market, being the head cylindrical instead of 27mm hexagonal.

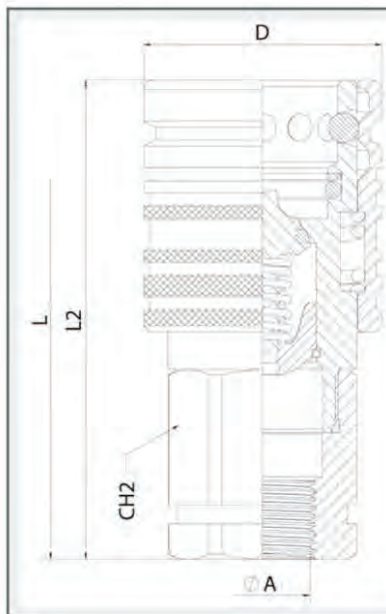

FEMALE					
DN	ØA	CH2	L2	ØD	L
10	1/4" BSP	22	66,5	31	99,07
	1/4" NPTF	22			
	3/8" BSP	22			
	3/8" NPTF	22			
	M16x1,5	22			
	M18x1,5	22			
13	3/8" BSP	27	37,80		113,80
	1/2" BSP	27			
	3/4" NPTF	30			
	M14x1,5	27			
	M16x1,5	27			
	M18,1,5	27			
	M22x1,5	27			
	3/4" -16ORB	27			
	7/8" -14ORB	27			
	* 3/4" -16ORB	27			

* DN13 FEMALE drawing

STANDARD FEMALE MODELS

DN	ØA	REF.	
10	1/4" BSP	107.12112AB	270Bar
	1/4" NPTF	107.12112BB	
	3/8" BSP	107.12112AC	
	3/8" NPTF	107.12112BC	
	M16x1,5	107.12112ND	
	M18x1,5	107.12112NE	
13	3/8" BSP	107.12113AC	250Bar
	1/2" BSP	107.12113AD	
	3/4" NPTF	107.12113BE	
	M14x1,5	107.12113NC	
	M16x1,5	107.12113ND	
	M18,1,5	107.12113NE	
	M22x1,5	107.12113NG	
	3/4" -16ORB	107.12113GF	
7/8" -14ORB	107.12113GH		
	* 3/4" -16ORB	107.12113GFA	

* This reference is habitually provided in the Spanish market, being the head cylindrical instead of 27mm hexagonal.