

Part number:

HYDROMA

HYDRAULICKÉ SYSTÉMY

**HIDROMA
SYSTEMS**

UKŁADY HYDRAULICZNE

HYDROMA

ГИДРАВЛИЧЕСКИЕ СИСТЕМЫ

GHP1

COME ORDINARE / HOW TO ORDER

GHP1	TIPO TYPE	ROTAZIONE ROTATION	TAGLIA SIZE	ALBERO* SHAFT*	PORTE* PORTS*	GUARNIZIONI* SEALS*	OPZIONI* OPTIONS*	DRENAGGIO* DRAIN*
	omit	D DESTRA CLOCKWISE	2					
	A	S SINISTRA COUNTER CLOCKWISE	3					
	AQ	R** REVERSIBILE REVERSIBLE	4					
	A2		5					
			6					
			7					
			9					
			11					
			13					
			16					
			20					

Guarnizioni / Seals
omit (T range = -10°C + 80°C)
V
H
...

Opzioni / Options
TR
RA
...

**Drenaggio (solo per rotazione R)
Drain (only for R rotation)**
E0 = drenaggio interno/internal drain
E1 = drenaggio esterno/external drain G1/4
*** E2 = drenaggio esterno/external drain 9/16-18 UNF
...

(*) = campi da specificare se diversi dallo standard "tipo pompa" / to be specified if different from standard pump type
(**) = La rotazione reversibile R è disponibile per tutte le taglie indicate / R rotation is available for all listed displacements
(***) = La porta di drenaggio "E2" è lavorata secondo la specifica SAE J1926/1 (ISO 11926-1) relativa a porte filettate con tenuta O-ring. Profondità utile 12,7 mm. / "E2" drain port is machined in compliance with threaded port with O-ring seal in truncated housing SAE J1926/1 (ISO 11926-1). Thread depth 12,7 mm.

Tipi Pompa Standard / Pump Standard Types

omit = flangia europea + albero T0 + porte E + guarnizioni standard / european flange + shaft T0 + ports E + standard seals
A = flangia A + albero C1 + porte FA + guarnizioni standard / flange A + shaft C1 + ports FA + standard seals
AQ = flangia AQ + albero C2 + porte FA + guarnizioni standard / flange AQ + shaft C2 + ports FA + standard seals
A2 = flangia A2 + albero C3 + porte FA + guarnizioni standard / flange A + shaft C3 + ports FA + standard seals

Esempi / Examples:

GHP1-D-2 = pompa destra, 1.4 cc/rev, flangia europea, albero conico 1:8, porte flangiate tipo E, guarnizioni standard
clockwise rotation, 1.4 cc/rev, european flange, 1:8 tapered shaft, flanged ports E type, standard seals
GHP1-D-2-FG-V = pompa destra, 1.4 cc/rev, flangia europea, albero conico 1:8, porte GAS (FG), guarnizioni per alta temperatura (V)
clockwise rotation, 1.4 cc/rev, european flange, 1:8 tapered shaft, threaded ports (FG), high temperature seals (V)
GHP1A-D-2-S1 = pompa destra, 1.4 cc/rev, flangia SAE A-A 2 fori, albero scanalato (S1), porte filettate (FA), guarnizioni standard
clockwise rotation, 1.4 cc/rev, SAE A-A 2 bolt flange, splined shaft 9T (S1), threaded ports (FA), standard seals

LE TAVOLE DI PRODOTTO RAPPRESENTANO I TIPI POMPA STANDARD PER MARZOCCHI POMPE. LE TAVOLE SINOTTICHE DI FLANGE, ALBERI E PORTE HANNO LO SCOPO DI RAPPRESENTARE TUTTE LE POSSIBILI CONFIGURAZIONI DI PRODOTTO. PER MAGGIORI DETTAGLI SULLE DISPONIBILITÀ E CONDIZIONI DI FORNITURA, CONSIGLIAMO DI INTERPELLARE IL NOSTRO UFFICIO TECNICO-COMMERCIALE.

THE PRODUCT DATA SHEETS SHOW OUR STANDARD MODEL TYPES. THE SYNOPTIC TABLES FOR FLANGES, SHAFTS AND PORTS SHOW ALL THE POSSIBLE CONFIGURATIONS. FOR FURTHER DETAILS ABOUT THE AVAILABILITY OF EACH CONFIGURATION PLEASE CONTACT OUR SALES AND TECHNICAL DEPT.

GHP1

Parti accessorie a corredo della pompa standard: linguetta a disco (codice 522054), dado M10x1 (codice 523015), rosetta elastica spaccata (codice 523004).
Porte standard: filetti M6 profondità utile 13 mm.

Accessories supplied with the standard pump: woodruff key (code 522054), M10x1 exagonal nut (code 523015), washer (code 523004).
Standard ports: M6 threads depth 13 mm.

MANDATA
OUTLET

ASPIRAZIONE
INLET

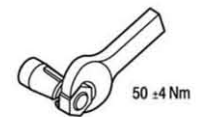
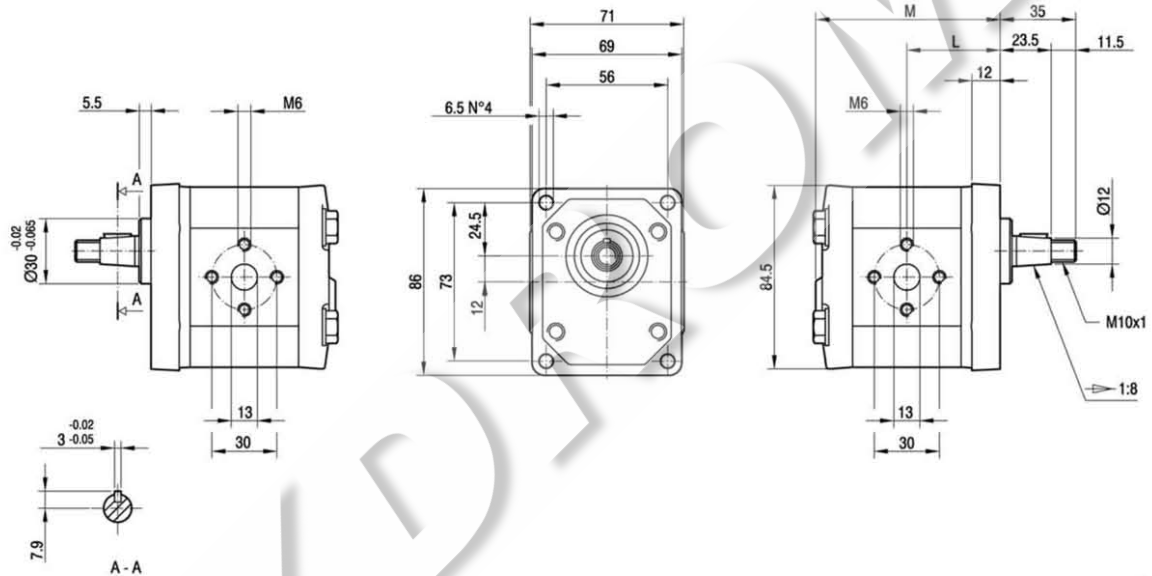

TIPO TYPE	CILINDRATA DISPLACEMENT	PORTATA a 1500 giri/min FLOW at 1500 rev/min	PRESSIONI MASSIME MAX PRESSURE			VELOCITÀ MASSIMA MAX SPEED	DIMENSIONI DIMENSIONS	
			P ₁	P ₂	P ₃		L	M
	cm ³ /giro [cm ³ /rev]	litri/min [litres/min]	bar	bar	bar	giri/min [rpm]	mm	mm
GHP1-D-2	1,4	2,0	270	290	310	6000	40	79
GHP1-D-3	2,1	2,9	270	290	310	6000	41	81
GHP1-D-4	2,8	3,9	270	290	310	5000	42	83
GHP1-D-5	3,5	4,9	270	290	310	5000	43	85
GHP1-D-6	4,1	5,9	270	290	310	4000	44	87
GHP1-D-7	5,2	7,4	260	275	290	4000	45,5	90
GHP1-D-9	6,2	8,8	260	275	290	3800	47	93
GHP1-D-11	7,6	10,8	230	245	260	3200	49	97
GHP1-D-13	9,3	13,3	210	225	240	2600	51,5	102
GHP1-D-16	11,0	15,7	200	215	230	2200	54	107
GHP1-D-20	13,8	19,7	180	195	210	1800	58	115

GHP1

FLANGE / FLANGES

ALBERI / SHAFTS

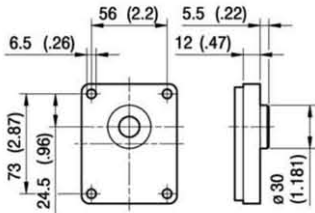

T0

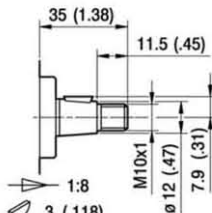

C0

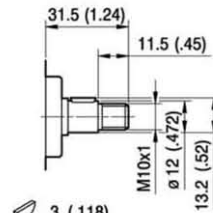

G0

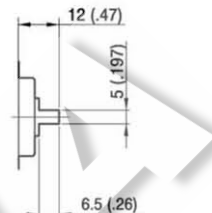

G0

Coppia Max
Max Torque 100 Nm

Coppia Max
Max Torque 55 Nm

Coppia Max
Max Torque 45 Nm

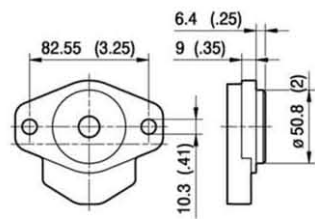

A

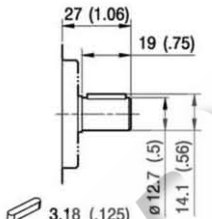

C1

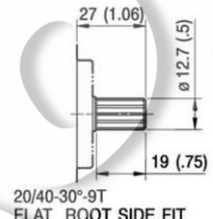

S1

Coppia Max
Max Torque 60 Nm

Coppia Max
Max Torque 100 Nm

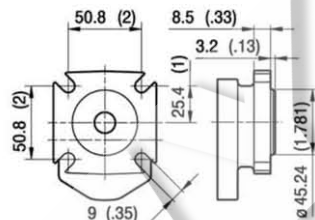

AQ

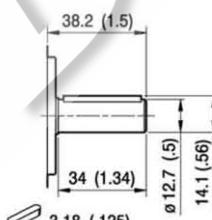

C2

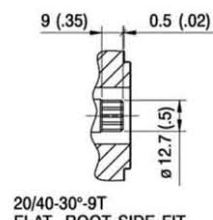

S2

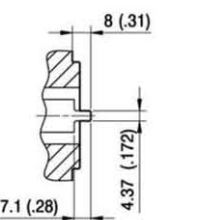

G1

Coppia Max
Max Torque 100 Nm

Coppia Max
Max Torque 95 Nm

Coppia Max
Max Torque 45 Nm

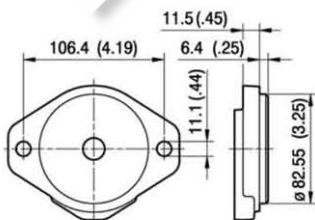

A2

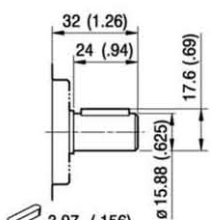

C3

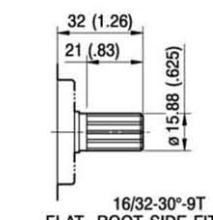

S3

Coppia Max
Max Torque 120 Nm

Coppia Max
Max Torque 145 Nm

GHP1

PORTE / PORTS

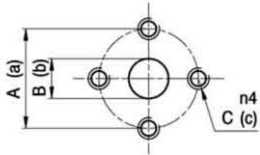

TIPO TYPE	ASPIRAZIONE INLET			MANDATA OUTLET		
	A	B	C	a	b	c
GHP1...2÷GHP1...20	30	13	M6	30	13	M6

I valori delle coppie di serraggio delle viti presenti nel kit raccordo sono indicate a pag. 55 (capitolo accessori).
Tightening torques of the fittings screws are specified on page 55 (accessories section).

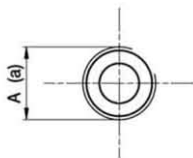

TIPO TYPE	ASPIRAZIONE INLET	MANDATA OUTLET
	A	a
GHP1...2÷GHP1...5	G1/2	G3/8
GHP1...6÷GHP1...20	G1/2	G1/2

Raccordo G1/2 coppia di serraggio massima 50 Nm. Raccordo G3/8 coppia di serraggio massima 35 Nm.
Consigliamo di richiedere conferma al fornitore del raccordo.
Tightening torques for G1/2 fitting: 50 Nm. Tightening torques for G3/8 fitting: 35 Nm. Please check with the fittings suppliers.

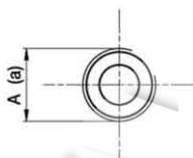

TIPO TYPE	ASPIRAZIONE INLET	MANDATA OUTLET
	A	a
GHP1...2÷GHP1...20	Rc1/2	Rc1/2

Raccordo Rc1/2 coppia di serraggio massima 50 Nm.
Consigliamo di richiedere conferma al fornitore del raccordo.
Tightening torques for Rc1/2 fitting: 50 Nm. Please check with the fittings suppliers.

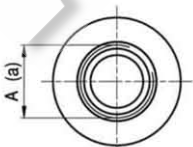

STANDARD SAE J1926/1

TIPO TYPE	ASPIRAZIONE INLET	MANDATA OUTLET
	A	a
GHP1...2÷GHP1...9	3/4-16 UNF	9/16-18 UNF
GHP1...11÷GHP1...20	7/8-14 UNF	3/4-16 UNF

Raccordo 9/16-18 UNF coppia di serraggio massima 30 Nm. Raccordo 3/4-16 UNF coppia di serraggio massima 60 Nm.
Raccordo 7/8-14 UNF coppia di serraggio massima 70 Nm. Consigliamo di richiedere conferma al fornitore del raccordo.
Tightening torques for 9/16-18 UNF fitting: 30 Nm. Tightening torques for 3/4-16 UNF fitting: 60 Nm.
Tightening torques for 7/8-14 UNF fitting: 70 Nm. Please check with the fittings suppliers.

GHP1 CURVE CARATTERISTICHE

GHP1 PERFORMANCE CURVES

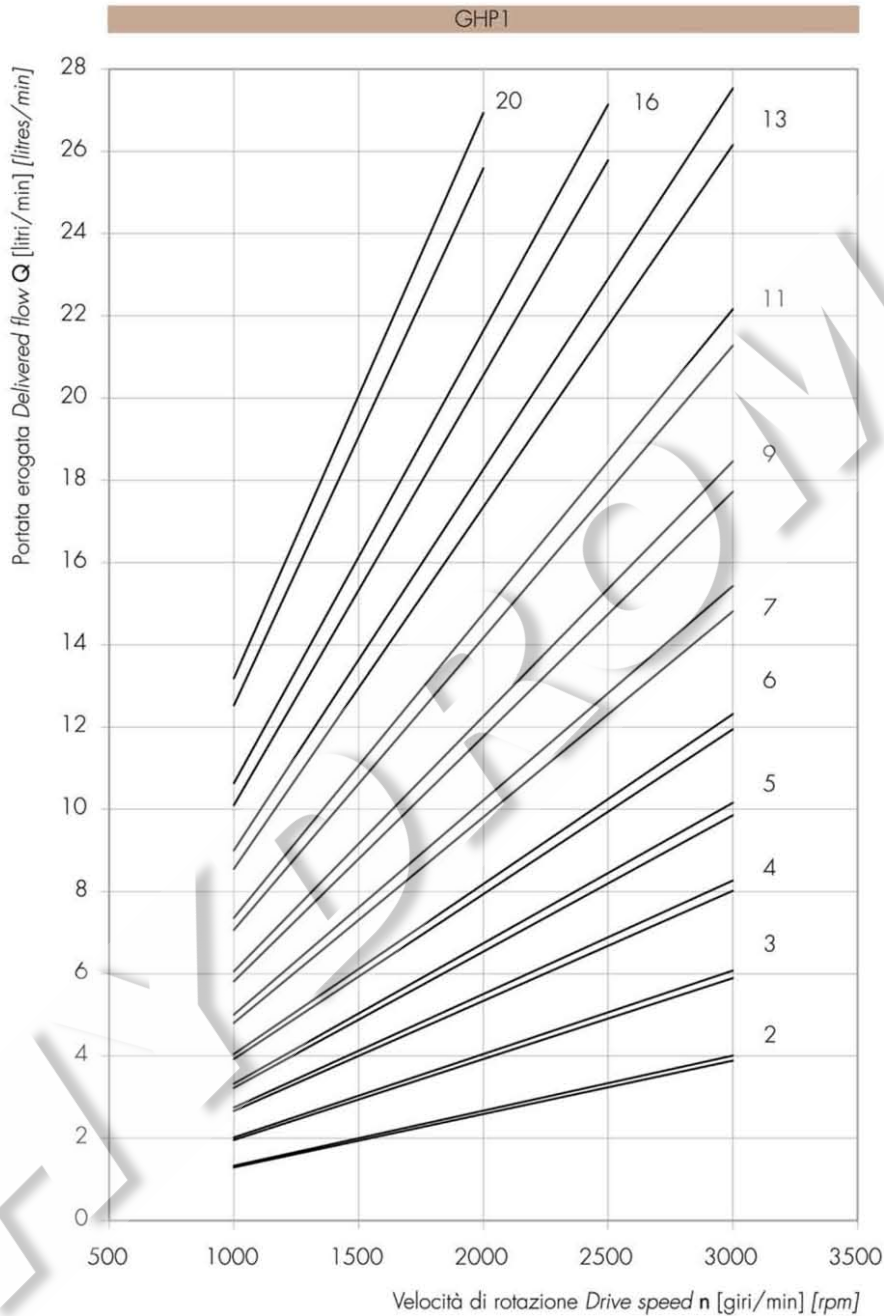

Le curve sono state ottenute alla temperatura di 50°C, utilizzando olio con viscosità 30 cSt alle pressioni sotto riportate.

Each curve has been obtained at 50°C, using oil with viscosity 30 cSt at these pressure.

2 |
3 |— 25-300 bar
4 |

7 |
9 |— 25-270 bar

16 |— 25-170 bar

5 |
6 |— 25-280 bar

11 |— 25-230 bar

20 |— 25-150 bar

13 |— 25-190 bar

Potenza assorbita Absorbed power P [kW]
 Momento torcente assorbito Absorbed torque M [Nm]
 Velocità di rotazione Drive speed n [giri/min] [rpm]

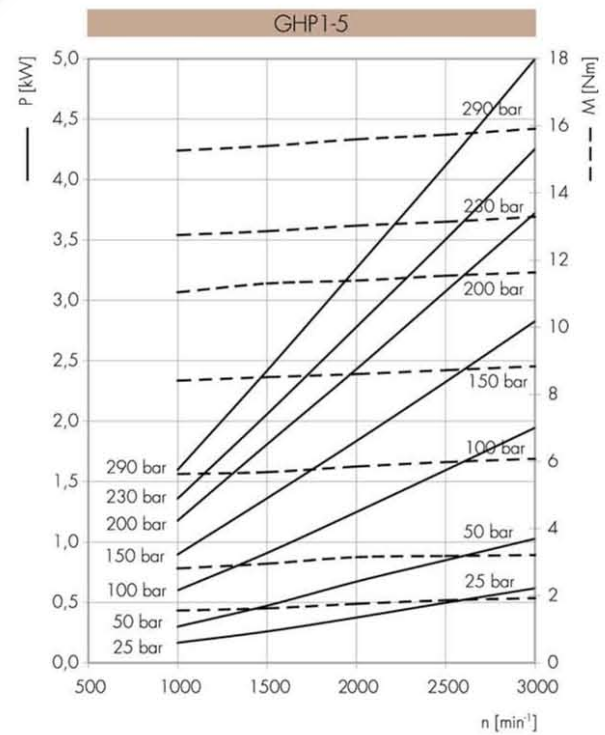
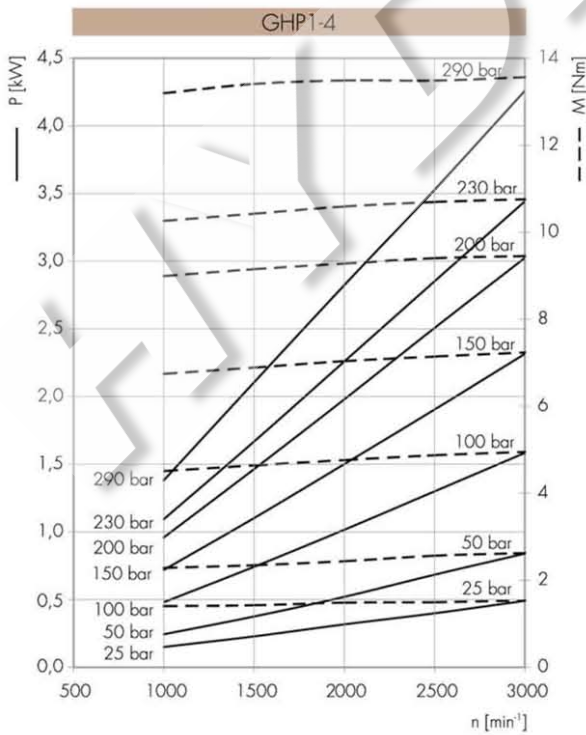
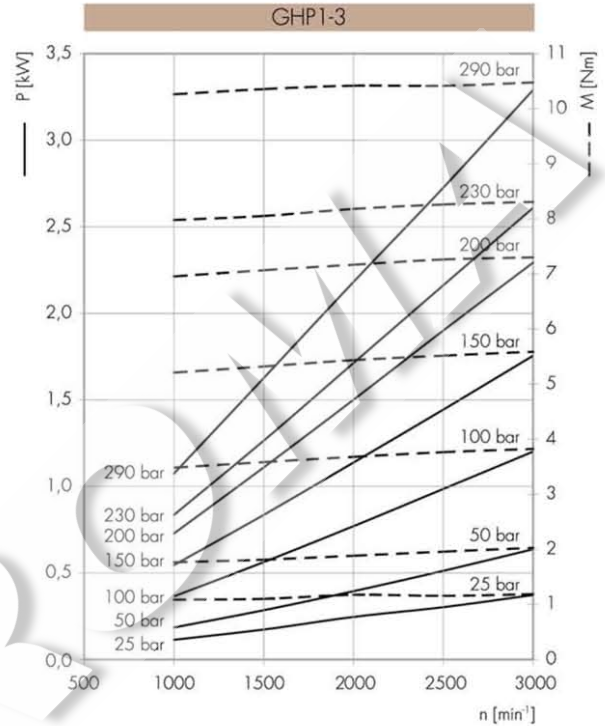
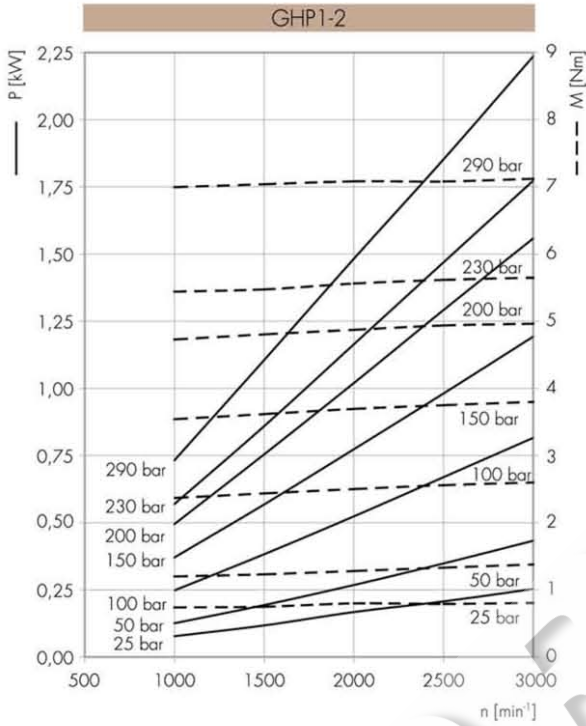

Potenza assorbita Absorbed power P [kW]
 Momento torcente assorbito Absorbed torque M [Nm]
 Velocità di rotazione Drive speed n [giri/min] [rpm]

