

Part number:

**HYDROMA**

HYDRAULICKÉ SYSTÉMY

**HIDROMA**  
SYSTEMS

UKŁADY HYDRAULICZNE

**HYDROMA**

ГИДРАВЛИЧЕСКИЕ СИСТЕМЫ

# FPB-MHT

## PRESSURE FILTERS

### MATERIALS

Head: Cast iron

Bowl: Steel

Bypass valve: Steel

Seals: NBR Nitrile (FKM - on request fluoroelastomer)

Indicator housing: Brass

### PRESSURE

Max working: 42 MPa (420 bar)

Collapse, differential for the filter element (ISO 2941):

series standard 2 MPa (20 bar)

series H+ 21 MPa (210 bar)

### BYPASS VALVE

Setting: 600 kPa (6 bar)  $\pm$  10%

### WORKING TEMPERATURE

From -25° to +110° C

### COMPATIBILITY (ISO 2943)

Full with fluids: HH-HL-HM-HV-HTG

(according to ISO 6743/4)

For fluids different than the above mentioned,  
please contact our Customer Service

### HYDRAULIC DIAGRAM

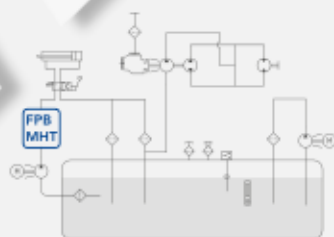

Is this datasheet the latest release? Please check on our website.



# FPB

## PRESSURE FILTERS

### ORDERING AND OPTION CHART

F	P	B	COMPLETE FILTER FAMILY												FILTER ELEMENT FAMILY		
				11	12	13	21	22	31	32	33	34	35	SIZE & LENGHT	E	P	B
			<b>SIZE &amp; LENGHT</b>														
			<b>PORT TYPE</b>														
			B = BSP thread	B	B	B	B	B	B	B	B	B	B				
			N = NPT thread	N	N	N	N	N	N	N	N	N	N				
			S = SAE thread	S	S	S	S	S	S	S	S	S	S				
			F = SAE flange 3000 psi	-	-	-	F	F	F	F	F	F	F				
			G = SAE flange 6000 psi	-	-	-	G	G	G	G	G	G	G				
			<b>PORT SIZE</b>														
			04 = 1/2" (N04 not available)	04	04	04	-	-	-	-	-	-	-				
			06 = 3/4" (F06 not available)	06	06	06	06	06	-	-	-	-	-				
			08 = 1" (G08 not available; F08 for FPB2 only)	-	-	-	08	08	08	08	08	08	08				
			10 = 1" 1/4 (N10 not available)	-	-	-	-	-	10	10	10	10	10				
			12 = 1" 1/2 (G12 option not available)	-	-	-	-	-	12	12	12	12	12				
			<b>BYPASS VALVE</b>														
			W = without	W	W	W	W	W	W	W	W	W	W				
			C = 600 kPa (6 bar)	C	C	C	C	C	C	C	C	C	C				
			R = reverse flow valve*	-	-	-	R	R	R	R	R	R	R				
			P = reverse flow + bypass valve*	-	-	-	P	P	P	P	P	P	P				
			<b>SEALS</b>											<b>SEALS</b>			
			N = NBR Nitrile	N	N	N	N	N	N	N	N	N	N				
			F = FKM Fluoroelastomer	F	F	F	F	F	F	F	F	F	F				
			<b>FILTER MEDIA</b>											<b>FILTER MEDIA</b>			
			FA = fibreglass 5 µm(c) β>1.000 Δp 2MPa (20 bar)	FA	FA	FA	FA	FA	FA	FA	FA	FA	FA				
			FB = fibreglass 7 µm(c) β>1.000 Δp 2MPa (20 bar)	FB	FB	FB	FB	FB	FB	FB	FB	FB	FB				
			FC = fibreglass 12 µm(c) β>1.000 Δp 2MPa (20 bar)	FC	FC	FC	FC	FC	FC	FC	FC	FC	FC				
			FS = fibreglass 16 µm(c) β>1.000 Δp 2MPa (20 bar)	FS	FS	FS	FS	FS	FS	FS	FS	FS	FS				
			FD = fibreglass 21 µm(c) β>1.000 Δp 2MPa (20 bar)	FD	FD	FD	FD	FD	FD	FD	FD	FD	FD				
			FE = fibreglass 30 µm(c) β>1.000 Δp 2MPa (20 bar)	FE	FE	FE	FE	FE	FE	FE	FE	FE	FE				
			HA = fibreglass 5 µm(c) β>1.000 Δp 21MPa (210 bar)	HA	HA	HA	HA	HA	HA	HA	HA	HA	HA				
			HB = fibreglass 7 µm(c) β>1.000 Δp 21MPa (210 bar)	HB	HB	HB	HB	HB	HB	HB	HB	HB	HB				
			HC = fibreglass 12 µm(c) β>1.000 Δp 21MPa (210 bar)	HC	HC	HC	HC	HC	HC	HC	HC	HC	HC				
			HD = fibreglass 21 µm(c) β>1.000 Δp 21MPa (210 bar)	HD	HD	HD	HD	HD	HD	HD	HD	HD	HD				
			<b>CLOGGING INDICATOR **</b>														
			03 = port, plugged	03	03	03	03	03	03	03	03	03	03				
			5E = visual differential 500 kPa (5 bar)	5E	5E	5E	5E	5E	5E	5E	5E	5E	5E				
			5F = visual differential 800 kPa (8 bar)	5F	5F	5F	5F	5F	5F	5F	5F	5F	5F				
			6E = electrical differential 500 kPa (5 bar)	6E	6E	6E	6E	6E	6E	6E	6E	6E	6E				
			6F = electrical differential 800 kPa (8 bar)	6F	6F	6F	6F	6F	6F	6F	6F	6F	6F				
			7E = indicator 6E with LED	7E	7E	7E	7E	7E	7E	7E	7E	7E	7E				
			7F = indicator 6F with LED	7F	7F	7F	7F	7F	7F	7F	7F	7F	7F				
			T2 = elect. diff. 500 kPa (5 bar) with thermostat 30°C	T2	T2	T2	T2	T2	T2	T2	T2	T2	T2				
			T3 = elect. diff. 800 kPa (8 bar) with thermostat 30°C	T3	T3	T3	T3	T3	T3	T3	T3	T3	T3				
X	X		<b>ACCESSORIES</b>														
			XX = no accessory available	XX	XX	XX	XX	XX	XX	XX	XX	XX	XX				

\* Not standard version, please check availability with our Customer Service

\*\* When the filter is ordered with FKM seals, the first digit of the indicator code is a letter (please see Clogging Indicator Chapter for further details)

# MHT

## PRESSURE FILTERS



### ORDERING AND OPTION CHART

M	H	T	COMPLETE FILTER FAMILY	151	152	153	301	302	801	802	803	804	805	FILTER ELEMENT FAMILY	C	C	H
			SIZE & LENGHT											SIZE & LENGHT			
			FILTER MEDIA											FILTER MEDIA			
			FT = fibreglass 5 µm(c) β>1.000 Δp 2MPa (20 bar)	FT	FT	FT	FT	FT	FT	FT	FT	FT	FT				
			FC = fibreglass 7 µm(c) β>1.000 Δp 2MPa (20 bar)	FC	FC	FC	FC	FC	FC	FC	FC	FC	FC				
			FD = fibreglass 12 µm(c) β>1.000 Δp 2MPa (20 bar)	FD	FD	FD	FD	FD	FD	FD	FD	FD	FD				
			FS = fibreglass 16 µm(c) β>1.000 Δp 2MPa (20 bar)	FS	FS	FS	FS	FS	FS	FS	FS	FS	FS				
			FV = fibreglass 21 µm(c) β>1.000 Δp 2MPa (20 bar)	FV	FV	FV	FV	FV	FV	FV	FV	FV	FV				
			2T = fibreglass 5 µm(c) β>1.000 Δp 21MPa (210 bar)	2T	2T	2T	2T	2T	2T	2T	2T	2T	2T				
			2C = fibreglass 7 µm(c) β>1.000 Δp 21MPa (210 bar)	2C	2C	2C	2C	2C	2C	2C	2C	2C	2C				
			2D = fibreglass 12 µm(c) β>1.000 Δp 21MPa (210 bar)	2D	2D	2D	2D	2D	2D	2D	2D	2D	2D				
			2V = fibreglass 21 µm(c) β>1.000 Δp 21MPa (210 bar)	2V	2V	2V	2V	2V	2V	2V	2V	2V	2V				
			SEALS											SEALS			
			1 = NBR 1nitrile	1	1	1	1	1	1	1	1	1	1				
			2 = FKM Fluoroelastomer	2	2	2	2	2	2	2	2	2	2				
			BYPASS VALVE														
			S = without	S	S	S	S	S	S	S	S	S	S				
			C = 600 kPa (6 bar)	C	C	C	C	C	C	C	C	C	C				
			R = reverse flow valve*	-	-	-	R	R	R	R	R	R	R				
			P = reverse flow + bypass valve*	-	-	-	P	P	P	P	P	P	P				
			PORT TYPE														
			B = BSP thread	B	B	B	B	B	B	B	B	B	B				
			N = NPT thread	N	N	N	N	N	N	N	N	N	N				
			S = SAE thread	S	S	S	S	S	S	S	S	S	S				
			F = SAE flange 3000 psi	-	-	-	F	F	F	F	F	F	F				
			H = SAE flange 6000 psi	-	-	-	H	H	H	H	H	H	H				
			PORT SIZE*														
			3 = 1/2" (N3 not available)	3	3	3	-	-	-	-	-	-	-				
			4 = 3/4" (F4 not available)	4	4	4	4	4	-	-	-	-	-				
			5 = 1" (G5 not available; F5 for FPB2 only)	-	-	-	5	5	5	5	5	5	5				
			6 = 1" 1/4 (N6 not available)	-	-	-	-	-	6	6	6	6	6				
			7 = 1" 1/2 (G7 option not available)	-	-	-	-	-	7	7	7	7	7				
			CLOGGING INDICATOR														
			03 = port, plugged	03	03	03	03	03	03	03	03	03	03				
			5E = visual differential 500 kPa (5 bar)	5E	5E	5E	5E	5E	5E	5E	5E	5E	5E				
			5F = visual differential 800 kPa (8 bar)	5F	5F	5F	5F	5F	5F	5F	5F	5F	5F				
			6E = electrical differential 500 kPa (5 bar)	6E	6E	6E	6E	6E	6E	6E	6E	6E	6E				
			6F = electrical differential 800 kPa (8 bar)	6F	6F	6F	6F	6F	6F	6F	6F	6F	6F				
			7E = indicator 6E with LED	7E	7E	7E	7E	7E	7E	7E	7E	7E	7E				
			7F = indicator 6F with LED	7F	7F	7F	7F	7F	7F	7F	7F	7F	7F				
			T2 = elect. diff. 500 kPa (5 bar) with thermostat 30°C	T2	T2	T2	T2	T2	T2	T2	T2	T2	T2				
			T3 = elect. diff. 800 kPa (8 bar) with thermostat 30°C	T3	T3	T3	T3	T3	T3	T3	T3	T3	T3				
X	X		ACCESSORIES														
			XX = no accessory available	XX	XX	XX	XX	XX	XX	XX	XX	XX	XX				

\* Not standard version, please check availability with our Customer Service

\*\* When the filter is ordered with FKM seals, the first digit of the indicator code is a letter (please see Clogging Indicator Chapter for further details)

# FPB-MHT

## PRESSURE FILTERS

### SPARE PARTS ELEMENTS

FILTER HOUSING	FILTER ELEMENT	CLOGGING INDICATOR
		
<b>B</b>   <b>P</b>   <b>B</b>                     <b>X</b>   <b>X</b>	<b>E</b>   <b>P</b>   <b>B</b>	<input type="checkbox"/>

### SPARE SEAL KIT

	NBR	FKM
FPB11 MHT151	521.0002.2	521.0086.2
FPB12 MHT152	521.0002.2	521.0086.2
FPB13 MHT153	521.0002.2	521.0086.2
FPB21 MHT301	521.0003.2	521.0030.2
FPB22 MHT302	521.0003.2	521.0030.2
FPB31 MHT801	521.0004.2	521.0087.2
FPB32 MHT802	521.0004.2	521.0087.2
FPB33 MHT803	521.0004.2	521.0087.2
FPB34 MHT804	521.0004.2	521.0087.2
FPB35 MHT805	521.0004.2	521.0087.2

## INSTALLATION DRAWING

FPB1

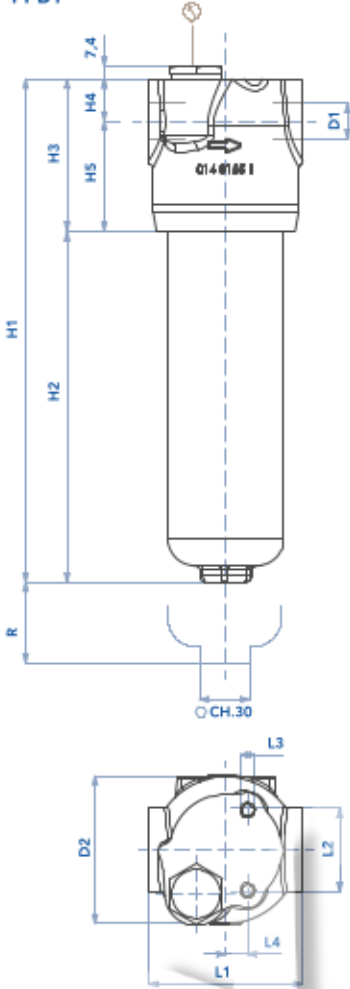

FPB2

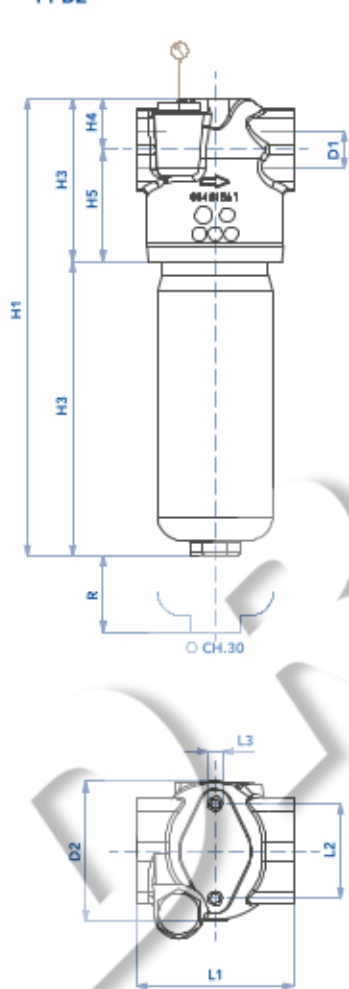

FPB 31-32-33

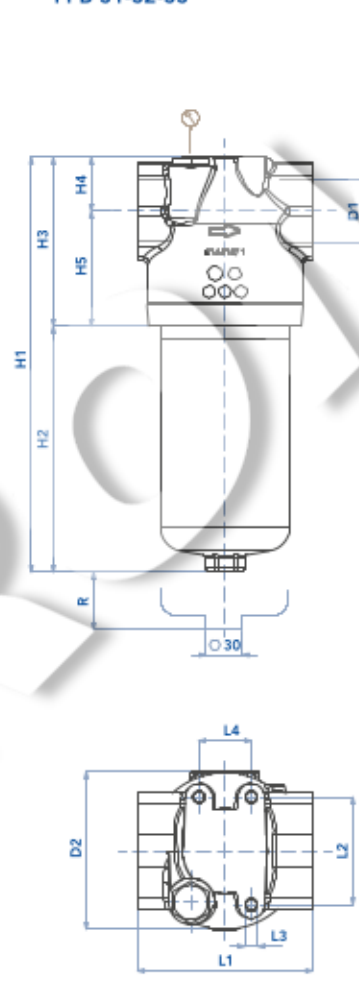

FPB 34-35

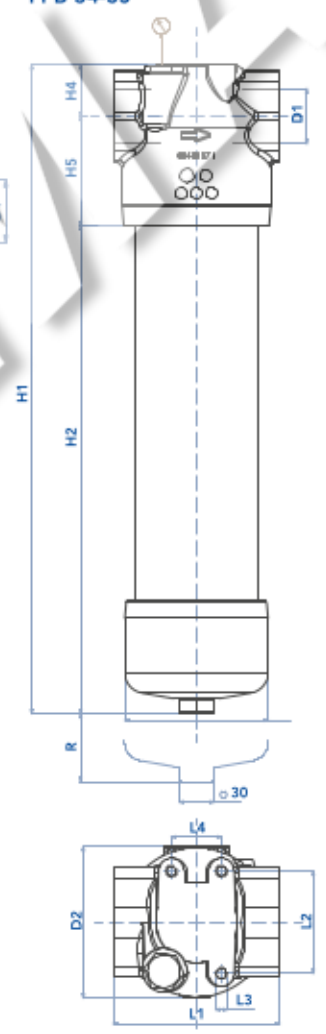

## FILTER HOUSING

	D1	D2	H1	H2	H3	H4	H5	L1	L2	L3	L4	R	Kg
FPB11 MHT151	1/2"-3/4"	86	166	79	87	24	63	88	46	M8	12,5	100	4,4
FPB12 MHT152	1/2"-3/4"	86	196	109	87	24	63	88	46	M8	12,5	100	4,6
FPB13 MHT153	1/2"-3/4"	86	296	209	87	24	63	88	46	M8	12,5	100	5,2
FPB21 MHT301	3/4" - 1"	94	226	116	112	35	77	108	65	M8	-	100	6,6
FPB22 MHT302	3/4" - 1"	94	317	207	112	35	77	108	65	M8	-	100	8,2
FPB31 MHT801	1" - 1 1/4" - 1 1/2"	128	245	107	138	44	94	143	88	M10	43	100	11,0
FPB32 MHT802	1" - 1 1/4" - 1 1/2"	128	337	199	138	44	94	143	88	M10	43	100	13,9
FPB33 MHT803	1" - 1 1/4" - 1 1/2"	128	457	319	138	44	94	143	88	M10	43	100	17,2
FPB34 MHT804	1" - 1 1/4" - 1 1/2"	128	558	420	138	44	94	143	88	M10	43	100	22,0
FPB35 MHT805	1" - 1 1/4" - 1 1/2"	128	658	520	138	44	94	143	88	M10	43	100	25,0

# FPB-MHT

## PRESSURE FILTERS

### MAINTENANCE

The best time to change your filter element is just before it reaches its maximum dirt-holding capacity. For this reason, we recommend to monitor the pressure of the hydraulic oil flowing through the filter with a clogging indicator. When it is time to change the filter element, switch off the system before opening the filter housing and make sure there is no pressure in the filter. Unscrew the bowl and remove the dirty filter element. Replace it with an original UFI element, verifying the

part number on the filter label or on the catalogue. Clean the bowl; check the gaskets conditions and replace if necessary. Insert the clean element into his seat, handling with care and cleanliness. Screw the housing until it stops, with a tightening torque of 70 Nm +5/0. We recommend the stocking of a spare UFI filter element for timely replacement when required.

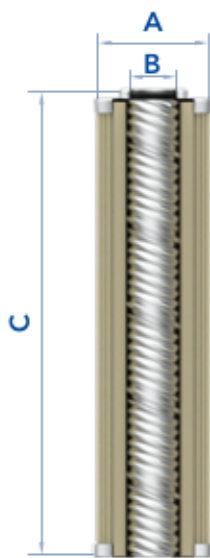

### FILTER ELEMENT

				Kg	Kg	AREA (cm <sup>2</sup> )	
	A	B	C	Media F	Media H	Media F+	Media H+
EPB11 CCH151	45	25	85	0,15	0,25	355	340
EPB12 CCH152	45	25	116	0,20	0,55	500	475
EPB13 CCH153	45	25	211	0,30	0,45	935	915
EPB21 CCH301	52	23,5	115	0,25	0,40	975	975
EPB22 CCH302	52	23,5	210	0,35	0,55	1.830	1.785
EPB31 CCH801	78	42,5	118	0,40	0,70	2.000	1.470
EPB32 CCH802	78	42,5	210	0,80	1,30	3.695	2.695
EPB33 CCH803	78	42,5	330	1,00	1,60	5.025	4.325
EPB34 CCH804	78	42,5	430	1,20	1,80	6.585	5.685
EPB35	78	42,5	530	1,40	2,00	8.145	7.045

The used filter elements cannot be cleaned and are classified as "Dangerous waste material". They must be disposed according to local laws by authorized Companies. Verify that the Company you choose has the expertise and authorization to dispose this type of waste material.

## PRESSURE DROP CURVES ( $\Delta p$ )

The "Assembly Pressure Drop ( $\Delta p$ )" is obtained by adding the pressure drop values of the Filter Housing and of the Clean Filter Element corresponding to the considered Flow

Rate and it must be lower than 120 kPa (1,2 bar) and should never exceed 1/3 of the bypass setting.

FILTER HOUSING PRESSURE DROP  
(mainly depending on the port size)

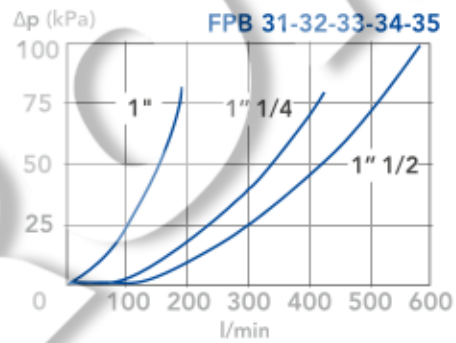
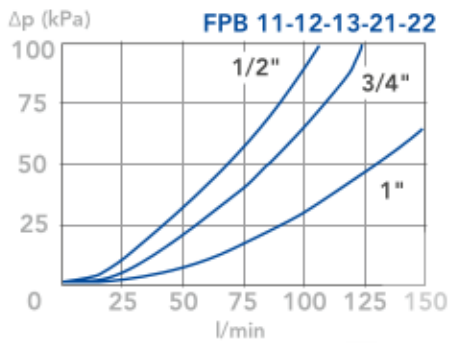

CLEAN FILTER ELEMENT PRESSURE DROP WITH F+ MEDIA  
(depending both on the internal diameter of the element and on the filter media)

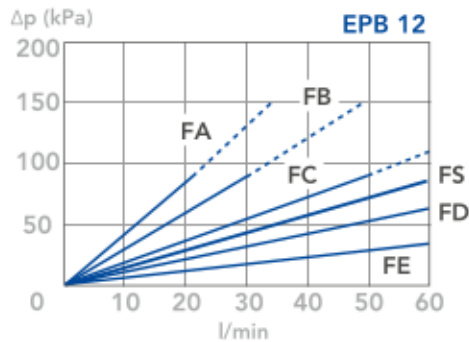
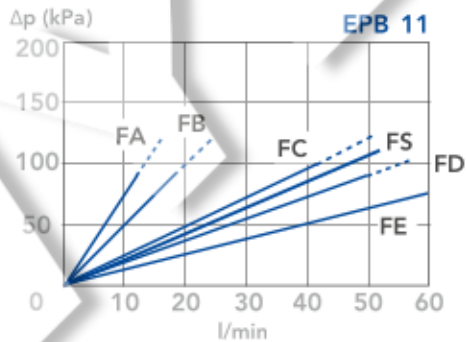

# FPB-MHT

## PRESSURE FILTERS

CLEAN FILTER ELEMENT PRESSURE DROP WITH F+ MEDIA  
 (depending both on the internal diameter of the element and on the filter media)

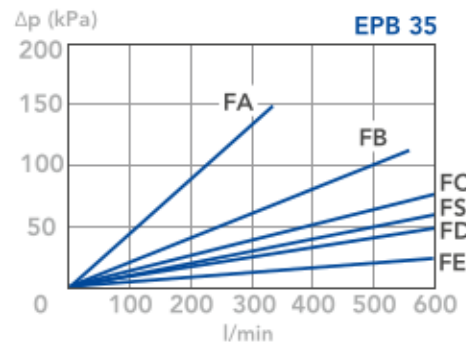
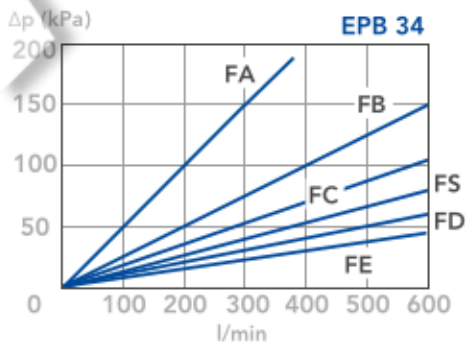
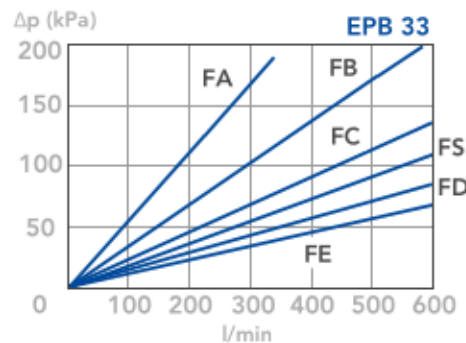
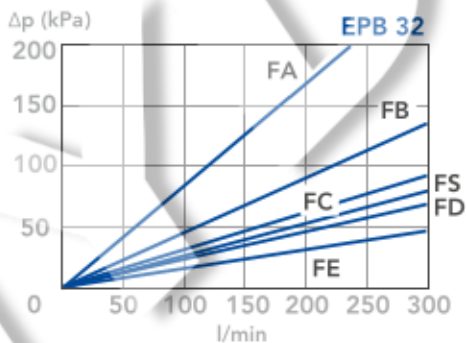
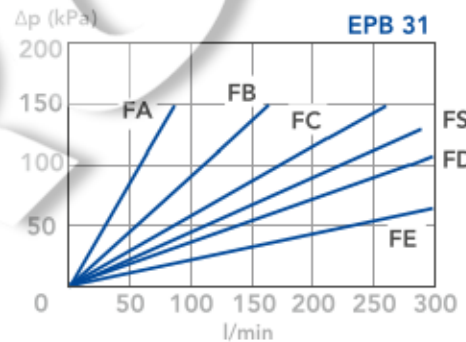
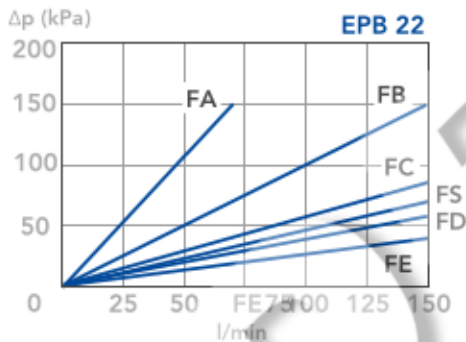
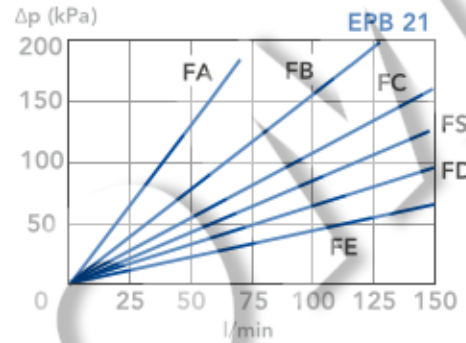
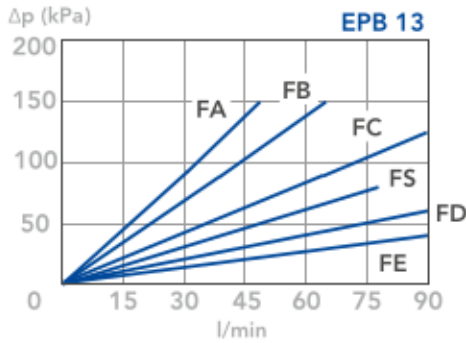



CLEAN FILTER ELEMENT PRESSURE DROP WITH H+ MEDIA  
 depending both on the internal diameter of the element and on the  
 filter media) - Recommended with no bypass option

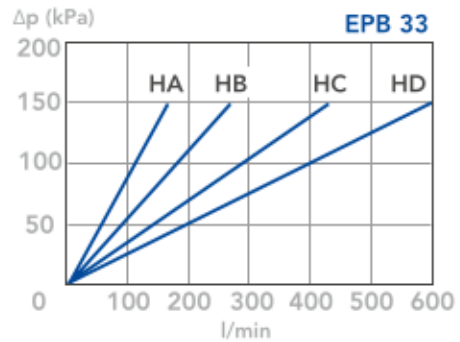
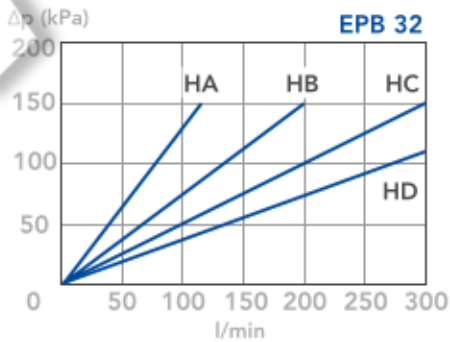
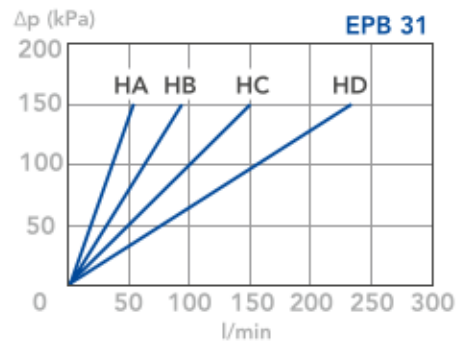
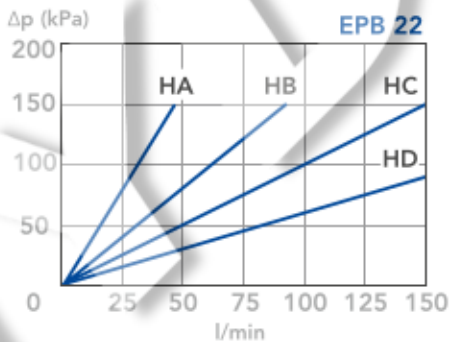
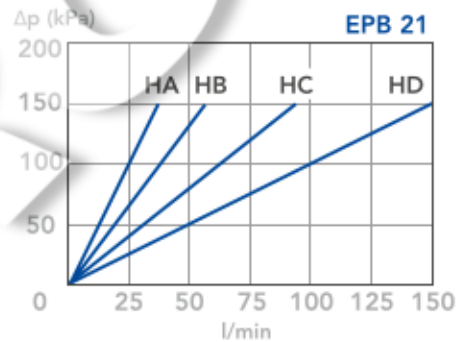
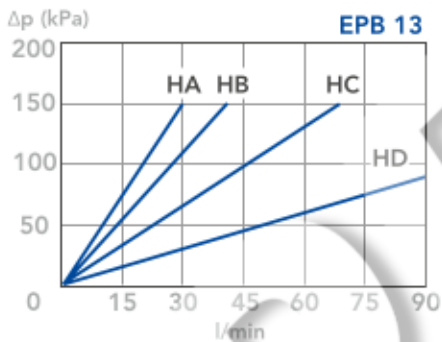
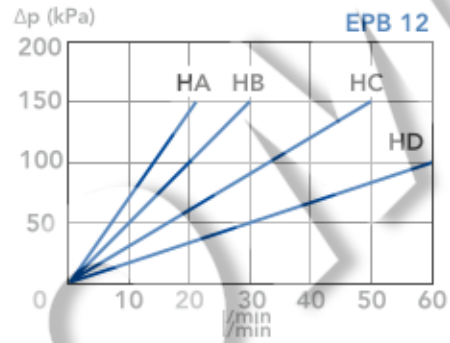
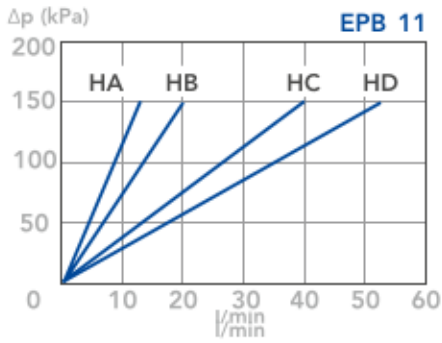

# FPB-MHT

## PRESSURE FILTERS

### CLEAN FILTER ELEMENT PRESSURE DROP WITH H+ MEDIA

depending both on the internal diameter of the element and on the filter media) - Recommended with no bypass option

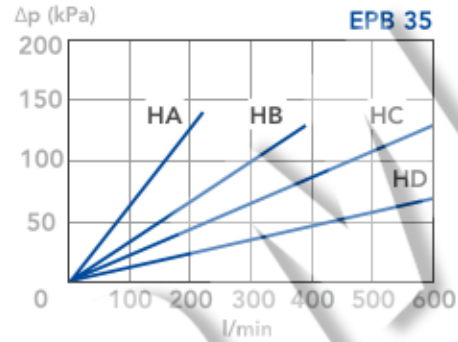
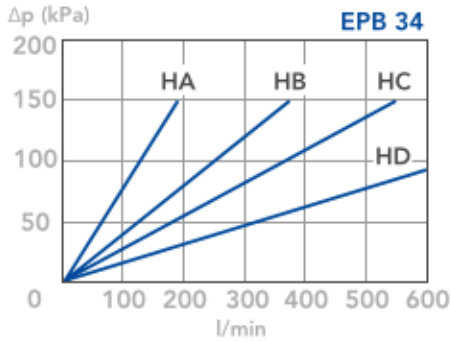

### BYPASS VALVE PRESSURE DROP

When selecting the filter size, these curves must be taken into account if it is foreseen that any flow peak is to be absorbed by the bypass valve, it also must be of proper configuration to avoid pressure peaks. The valve pressure drop is directly proportional to fluid specific gravity.

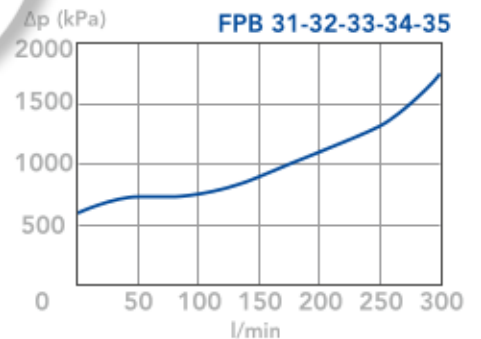
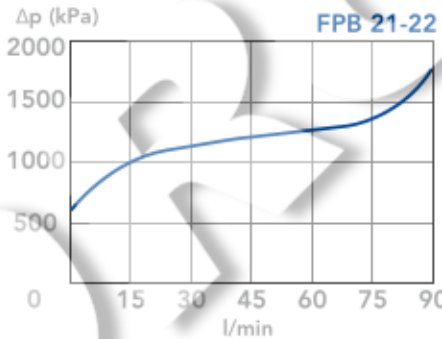
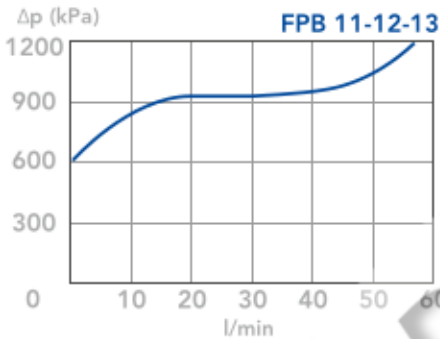

### REVERSE FLOW VALVE

For hydraulic systems where reverse flow can occur, the pressure filters series FPB2+ and FPB3+ are available with a free reverse flow valve allowing the fluid to pass through the filter element in the normal direction and to bypass the filter element in the reverse direction (option "R").

The reverse flow valve is available also with incorporated bypass valve for the normal flow direction, set at 6 bar (option "P").

In normal flow conditions the whole flow pass through the filter element. In the option "P", if the differential pressure across the element exceeds 6 bar the bypass is activated.

In reverse flow conditions the flow bypasses the filter element.

Pressure drop through the valve in the reverse direction:

0,4 bar at 100 L/min

0,6 bar at 200 L/min

0,8 bar at 300 L/min

### NORMAL FLOW

### REVERSE FLOW

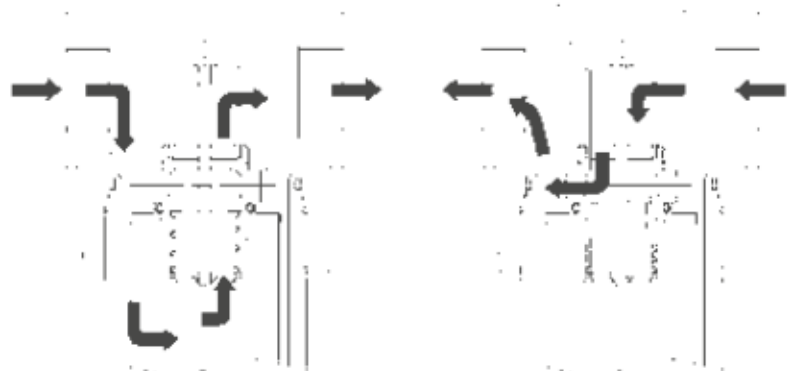

### N.B.

All the curves have been obtained with mineral oil having a kinematic viscosity 30 cSt and specific gravity 0,86 Kg/dm<sup>3</sup>; for fluids with different features, please consider the factors described in the first part of this catalogue. All the curves

are obtained from test done at the UFI HYDRAULIC DIVISION Laboratory, according to the specification ISO 3968. In case of discrepancy, please check the contamination level, viscosity and features of the fluid in use.