

Part number:

076-10970a

HYDROMA

HYDRAULICKÉ SYSTÉMY

**HIDROMA
SYSTEMS**

UKŁADY HYDRAULICZNE

HYDROMA

ГИДРАВЛИЧЕСКИЕ СИСТЕМЫ

ALM1

COME ORDINARE / HOW TO ORDER

ALM1	TIPO TYPE	ROTAZIONE ROTATION	TAGLIA SIZE	ALBERO* SHAFT*	PORTE* PORTS*	GUARNIZIONI* SEALS*	OPZIONI* OPTIONS*	DRENAGGIO** DRAIN**
	omit	D DESTRA CLOCKWISE	...					
	A	S SINISTRA COUNTER CLOCKWISE	...					
		R REVERSIBILE REVERSIBLE	4					
			5					
			6					
			7					
			9					
			11					
			13					
			16					
			...					

Guarnizioni / Seals
omit (T range = -10°C + 80°C)
V
...
Opzioni / Options
...
Drenaggio / Drain
E0 = drenaggio interno / internal drain
→ E1 = drenaggio esterno / external drain G1/4
*** E2 = drenaggio esterno / external drain 9/16-18 UNF
...
(*) = campi da specificare se diversi dallo standard "tipo motore" / to be specified if different from standard "motor type"
(**) = solo per rotazione R / only for R rotation
(***) = la porta di drenaggio "E2" è lavorata secondo la specifica SAE J1926/1 (ISO 11926-1) relativa a porte filettate con tenuta O-ring. Profondità utile 12,7 mm. / "E2" drain port is machined in compliance with threaded port with O-ring seal in truncated housing SAE J1926/1 (ISO 11926-1). Thread depth 12,7 mm.

Tipi Motore Standard / Motor Standard Types

omit = flangia europea + albero T0 + porte E + guarnizioni standard / european flange + shaft T0 + ports E + standard seals
 A = flangia A + albero C1 + porte FA + guarnizioni standard / flange A + shaft C1 + ports FA + standard seals

Esempi / Examples:

ALM1-D-2 = motore destro, 1.4 cc/rev, flangia europea, albero conico 1:8, porte flangiate tipo E, guarnizioni standard
 clockwise rotation, 1.4 cc/rev, european flange, 1:8 tapered shaft, flanged ports E type, standard seals
 ALM1-D-2-FG-V = motore destro, 1.4 cc/rev, flangia europea, albero conico 1:8, porte GAS (FG), guarnizioni per alta temperatura (V)
 clockwise rotation, 1.4 cc/rev, european flange, 1:8 tapered shaft, threaded ports (FG), high temperature seals (V)
 ALM1A-D-2-S1 = motore destro, 1.4 cc/rev, flangia SAE A-A 2 fori, albero scanalato 9T (S1), porte filettate, guarnizioni standard
 clockwise rotation, 1.4 cc/rev, SAE A-A 2 bolt flange, 9T splined shaft (S1), threaded ports, standard seals
 ALM1-R-4-E1 = motore reversibile, 2.8 cc/rev, flangia europea, albero conico 1:8, porte flangiate tipo E, guarnizioni standard, dren. esterno (E1)
 reversible motor, 2.8 cc/rev, european flange, 1:8 tapered shaft, flanged ports E type, standard seals, external drain (E1)

LE TAVOLE DI PRODOTTO RAPPRESENTANO I TIPI MOTORE STANDARD PER MARZOCCHI POMPE. LE TAVOLE SINOTTICHE DI FLANGE, ALBERI E PORTE HANNO LO SCOPO DI RAPPRESENTARE TUTTE LE POSSIBILI CONFIGURAZIONI DI PRODOTTO. PER MAGGIORI DETTAGLI SULLE DISPONIBILITÀ E CONDIZIONI DI FORNITURA, CONSIGLIAMO DI INTERPELLARE IL NOSTRO UFFICIO TECNICO-COMMERCIALE.

THE PRODUCT DATA SHEETS SHOW OUR STANDARD MODEL TYPES. THE SYNOPTIC TABLES FOR FLANGES, SHAFTS AND PORTS SHOW ALL THE POSSIBLE CONFIGURATIONS. FOR FURTHER DETAILS ABOUT THE AVAILABILITY OF EACH CONFIGURATION PLEASE CONTACT OUR SALES AND TECHNICAL DEPT.

Part number:

076-10970b

HYDROMA

HYDRAULICKÉ SYSTÉMY

**HIDROMA
SYSTEMS**

UKŁADY HYDRAULICZNE

HYDROMA

ГИДРАВЛИЧЕСКИЕ СИСТЕМЫ

ALM1

Parti accessorie a corredo della pompa standard: linguetta a disco (codice 522054), dado M10x1 (codice 523015), rosetta elastica spaccata (codice 523004).
Porte standard: filetti M6 profondità utile 13 mm.
Drenaggio G1/4 profondità utile 12 mm.

Accessories supplied with the standard pump: woodruff key (code 522054), M10x1 exagonal nut (code 523015), washer (code 523004).
Standard ports: M6 threads depth 13 mm.
G1/4 drain port thread depth 12 mm.

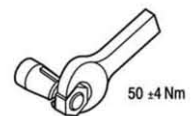
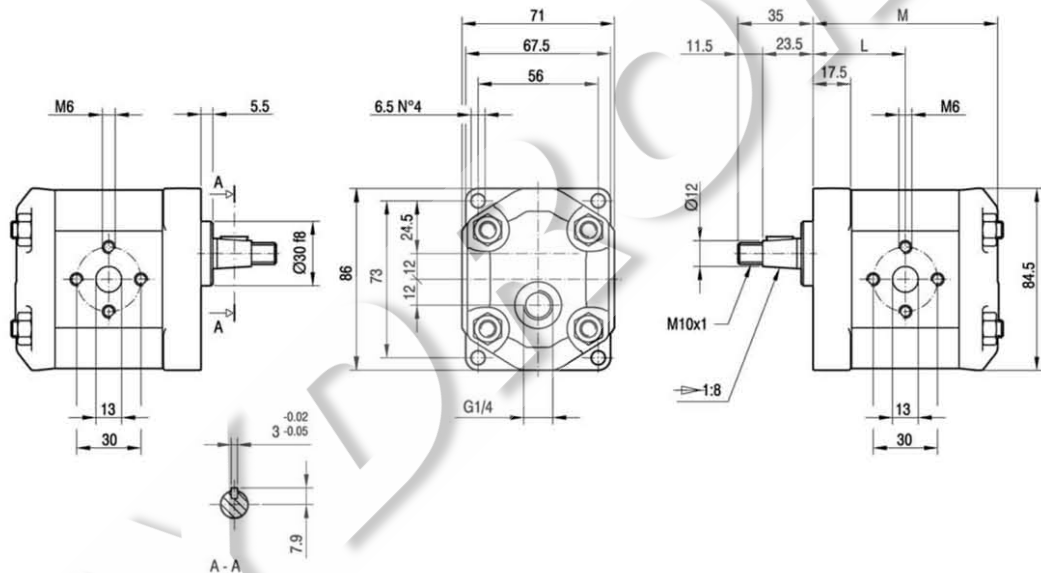

TIPO TYPE	CILINDRATA DISPLACEMENT	PORTATA a 1500 giri/min FLOW at 1500 rev/min	PRESSIONI MASSIME MAX PRESSURE			VELOCITÀ MASSIMA MAX SPEED	DIMENSIONI DIMENSIONS	
			P _I	P _C	P _P		L	M
	cm ³ /giro (cm ³ /rev)	litri/min (litres/min)	bar	bar	bar	giri/min (rpm)	mm	mm
ALM1-R-4-E1	2,8	3,9	250	240	270	5000	42	84,5
ALM1-R-5-E1	3,5	4,9	250	240	270	5000	43	86,5
ALM1-R-6-E1	4,1	5,9	250	240	270	4000	44	88,5
ALM1-R-7-E1	5,2	7,4	230	220	245	4000	45,5	91,5
ALM1-R-9-E1	6,2	8,8	230	220	245	3800	47	94,5
ALM1-R-11-E1	7,6	10,8	200	190	215	3200	49	98,5
ALM1-R-13-E1	9,3	13,3	180	170	195	2600	51,5	103,5
ALM1-R-16-E1	11,0	15,7	170	160	185	2200	54	108,5

Part number:

076-10970c

HYDROMA

HYDRAULICKÉ SYSTÉMY

**HIDROMA
SISTEMS**

UKŁADY HYDRAULICZNE

HYDROMA

ГИДРАВЛИЧЕСКИЕ СИСТЕМЫ

ALM1

FLANGE / FLANGES

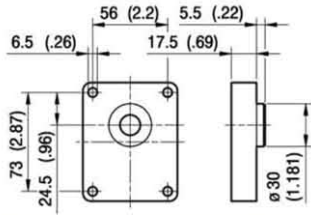

ALBERI / SHAFTS

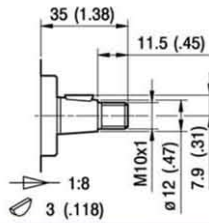

T0

Coppia Max
Max Torque 100 Nm

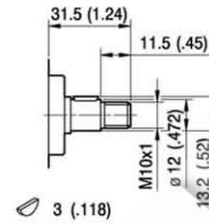

C0

Coppia Max
Max Torque 55 Nm

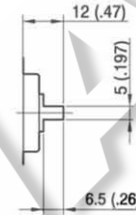

G0

Coppia Max
Max Torque 45 Nm

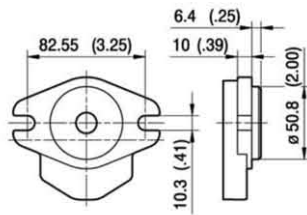

A

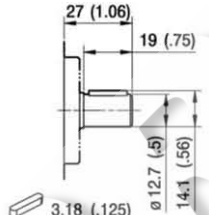

C1

Coppia Max
Max Torque 60 Nm

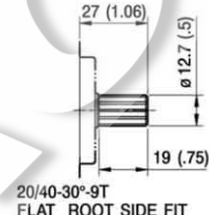

S1

Coppia Max
Max Torque 100 Nm

Part number:

076-10970d

HYDROMA

HYDRAULICKÉ SYSTÉMY

**HIDROMA
SYSTEMS**

UKŁADY HYDRAULICZNE

HYDROMA

ГИДРАВЛИЧЕСКИЕ СИСТЕМЫ

ALM1

PORTE / PORTS

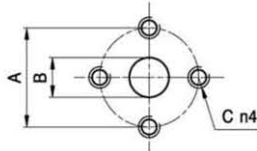

E

TIPO TYPE	MOTORE BIDIREZIONALE BI-DIRECTIONAL MOTOR			MOTORE MONODIREZIONALE MONO-DIRECTIONAL MOTOR		
	USCITA - ENTRATA OUTPUT - INPUT			ENTRATA INPUT		
	A	B	C	A	B	C
ALM1...4 ÷ ALM1...16	30	13	M6	30	13	M6

I valori delle coppie di serraggio delle viti presenti nel kit raccordo sono indicate a pag 46 (capitolo accessori).
Tightening torques of the fittings screws are specified on page 46 (accessories section).

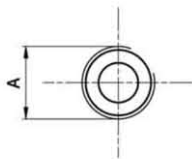

FG

TIPO TYPE	MOTORE BIDIREZIONALE BI-DIRECTIONAL MOTOR		MOTORE MONODIREZIONALE MONO-DIRECTIONAL MOTOR	
	USCITA - ENTRATA OUTPUT - INPUT		ENTRATA INPUT	
	A		A	
ALM1...4 ÷ ALM1...5	G1/2		G3/8	
ALM1...6 ÷ ALM1...16	G1/2		G1/2	

Raccordo G1/2 coppia di serraggio massima 50 Nm. Raccordo G3/8 coppia di serraggio massima 35 Nm.
Consigliamo di richiedere conferma al fornitore del raccordo.
Tightening torques for G1/2 fitting: 50 Nm. Tightening torques for G3/8 fitting: 35 Nm. Please check with the fittings suppliers.

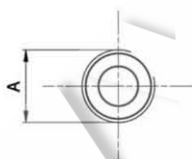

FC

TIPO TYPE	MOTORE BIDIREZIONALE BI-DIRECTIONAL MOTOR		MOTORE MONODIREZIONALE MONO-DIRECTIONAL MOTOR	
	USCITA - ENTRATA OUTPUT - INPUT		ENTRATA INPUT	
	A		A	
ALM1...4 ÷ ALM1...16	Rc1/2		Rc1/2	

Raccordo Rc1/2 coppia di serraggio massima 50 Nm.
Consigliamo di richiedere conferma al fornitore del raccordo.
Tightening torques for Rc1/2 fitting: 50 Nm. Please check with the fittings suppliers.

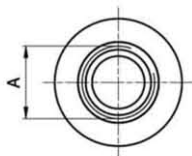

STANDARD SAE J1926/1

FA

TIPO TYPE	MOTORE BIDIREZIONALE BI-DIRECTIONAL MOTOR		MOTORE MONODIREZIONALE MONO-DIRECTIONAL MOTOR	
	USCITA - ENTRATA OUTPUT - INPUT		ENTRATA INPUT	
	A		A	
ALM1...4 ÷ ALM1...9	3/4-16 UNF		9/16-18 UNF	
ALM1...11 ÷ ALM1...16	7/8-14 UNF		3/4-16 UNF	

Raccordo 9/16-18 UNF coppia di serraggio massima 30 Nm. Raccordo 3/4-16 UNF coppia di serraggio massima 60 Nm.
Raccordo 7/8-14 UNF coppia di serraggio massima 70 Nm. Consigliamo di richiedere conferma al fornitore del raccordo.
Tightening torques for 9/16-18 UNF fitting: 30 Nm. Tightening torques for 3/4-16 UNF fitting: 60 Nm.
Tightening torques for 7/8-14 UNF fitting: 70 Nm. Please check with the fittings suppliers.

Part number:

076-10970e

HYDROMA

HYDRAULICKÉ SYSTÉMY

**HIDROMA
SYSTEMS**

UKŁADY HYDRAULICZNE

HYDROMA

ГИДРАВЛИЧЕСКИЕ СИСТЕМЫ

Potenza erogata *Delivered power* P [kW]

Momento torcente erogato *Delivered torque* M [Nm]

Velocità di rotazione *Drive speed* n [giri/min] [rpm]

