

Part number:

HYDROMA

HYDRAULICKÉ SYSTÉMY

**HIDROMA
SYSTEMS**

UKŁADY HYDRAULICZNE

HYDROMA

ГИДРАВЛИЧЕСКИЕ СИСТЕМЫ

81 220/107 ED



PRED3G

PRESSURE CONTROL VALVE WITH PROPORTIONAL CONTROL AND INTEGRATED ELECTRONICS SERIES 11

SUBPLATE MOUNTING
ISO 4401-03 (CETOP 03)

p max 350 bar
Q max 5 l/min

MOUNTING INTERFACE

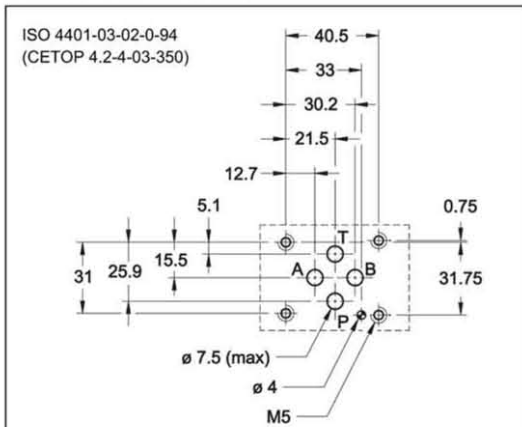

OPERATING PRINCIPLE

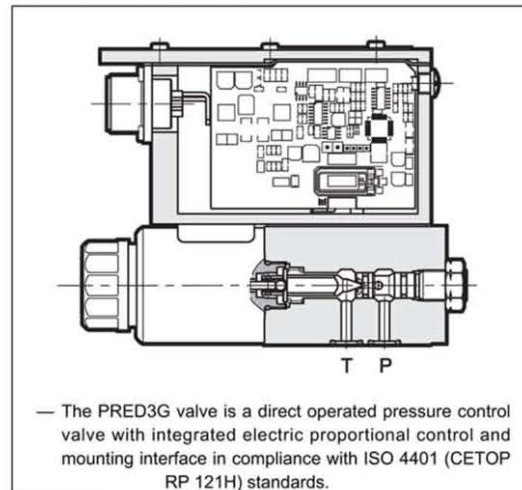

PERFORMANCES (obtained with mineral oil with viscosity of 36 cSt at 50°C and with digital integrated electronics)

Maximum operating pressure: - P port - T port	bar	350 2
Minimum controlled pressure	see diagram $p_{min} = f(Q)$	
Nominal flow	l/min	1
Maximum flow (see diagram $p_{min} = f(Q)$)		5
Step response	see paragraph 3	
Hysteresis	% of p nom	< 3%
Repeatability	% of p nom	< ±1%
Electrical characteristic	see paragraph 4.3	
Ambient temperature range	°C	-10 / +50
Fluid temperature range	°C	-20 / +80
Fluid viscosity range	cSt	10 ÷ 400
Fluid contamination degree	According to ISO 4406:1999 class 18/16/13	
Recommended viscosity	cSt	25
Mass:	kg	2

- It is suitable to pilot two-stage valves, for pressure control in hydraulic circuits.
- Pressure can be modulated continuously in proportion to the reference signal.
- The valve is controlled directly by an integrated digital amplifier (see par. 4).
- The valve is available in four pressure control ranges up to 350 bar.

HYDRAULIC SYMBOL

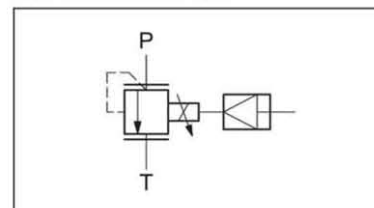

PRED3G

SERIES 11

1 - IDENTIFICATION CODE

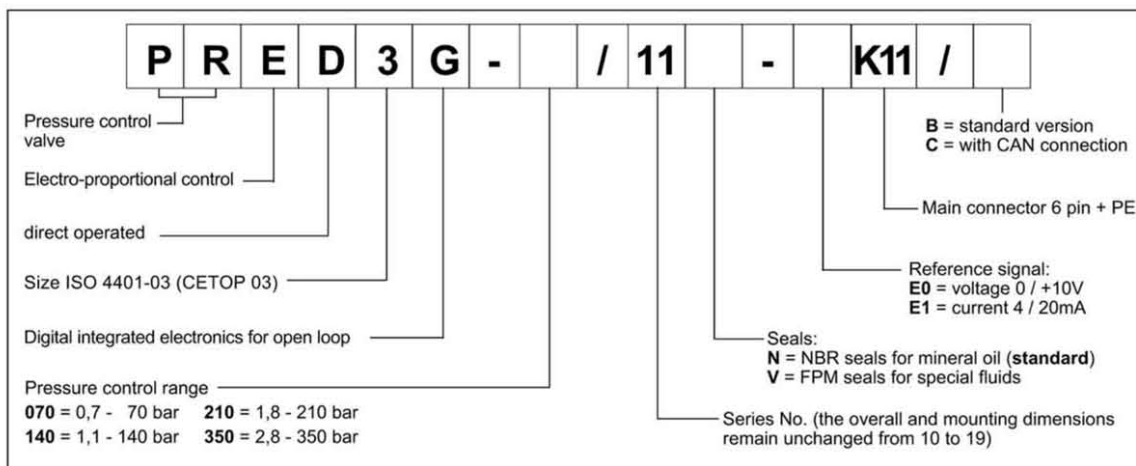

2 - CHARACTERISTIC CURVES (measured with viscosity of 36 cSt at 50°C)

Typical control curves according to the current supplied to the solenoid for pressure control ranges: 070, 140, 210, 350, measured with input flow rate $Q=1$ l/min. The curves are obtained after linearization in factory of the characteristic curve through the digital amplifier, and they are measured without any backpressure in T.

The full scale pressure is set in factory with a flow rate of 1 l/min. In case of higher flow rate, the full scale pressure will increase considerably (see diagram $p_{max} = f(Q)$)

PRESSURE CONTROL $p=f(I)$

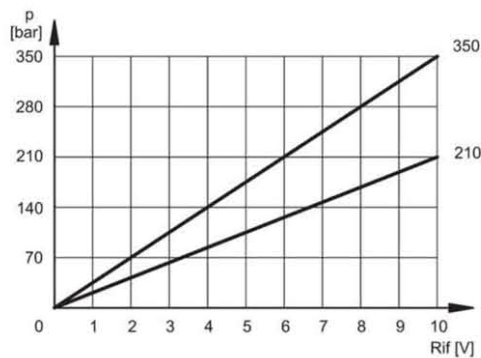
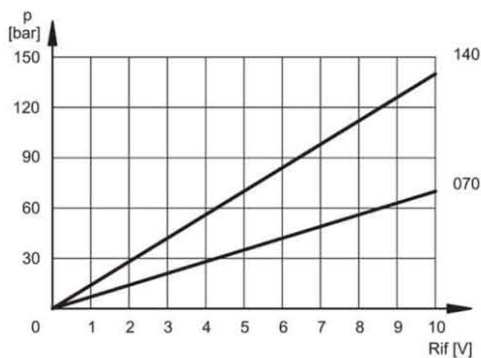

MINIMUM CONTROLLED PRESSURE $p_{min} = f(Q)$

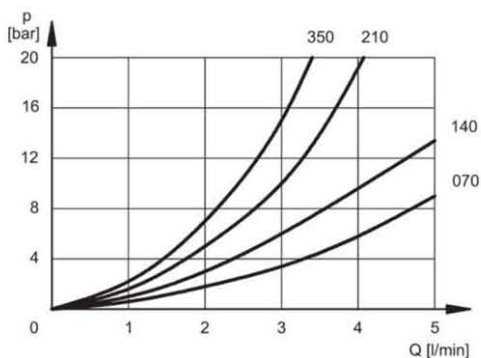

PRESSURE VARIATION $p_{max} = f(Q)$

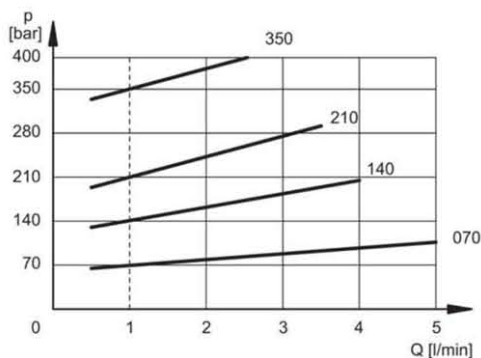

PRED3G

SERIES 11

3 - RESPONSE TIMES (obtained with mineral oil with viscosity of 36 cSt at 50°C and with digital integrated electronics)

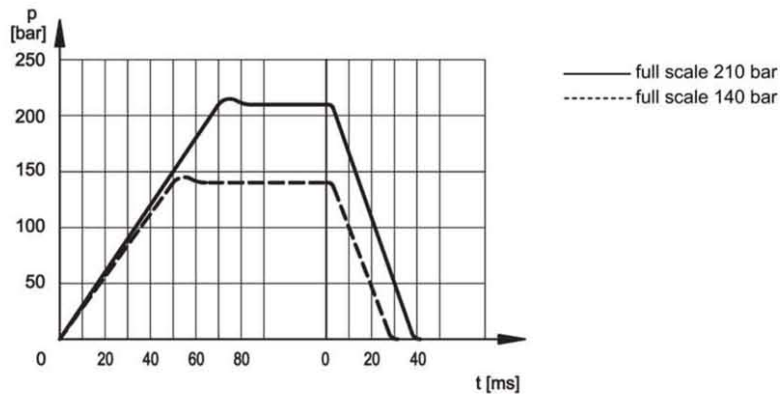

NOTE: Response times are obtained by using valves with a full scale of 140 and 210 bar, with an input flow rate of 2 l/min and a pressure oil volume of 0,5 lt. The response time is affected both by the flow rate and the oil volume in the pipework.

4 - ELECTRICAL CHARACTERISTICS

4.1 - Digital integrated electronics

The proportional valve is controlled by a digital amplifier (driver), which incorporates a microprocessor that controls, via software, all the valve functions, such as:

- continuous converting (0,5ms) of the voltage reference signal (E0) or of the current reference signal (E1) in a digital value
- generation of up and down ramps (see note)
- gains limit (see note)
- compensation of the dead band
- linearization of the characteristic curve
- regulation of the current to the solenoid
- dynamic regulation of PWM frequency
- protection of the solenoid outputs against possible short circuits

NOTE: these parameters can be set through the connection to the CAN connector, by means of a personal computer and relevant software (see par. 5.3)

The digital driver enables the valve to reach better performance compared to the analogic version, such as:

- reduced hysteresis and improved repeatability
- reduced response times
- linearization of the characteristic curve which is optimised in factory for each valve
- complete interchangeability in case of valve replacement
- possibility to set, via software, the functional parameters
- possibility to interface a CAN-Open network
- possibility to perform a diagnostic program by means of the CAN connection
- high immunity to electromagnetic troubles

PRED3G

SERIES 11

4.2 - Functional block diagram

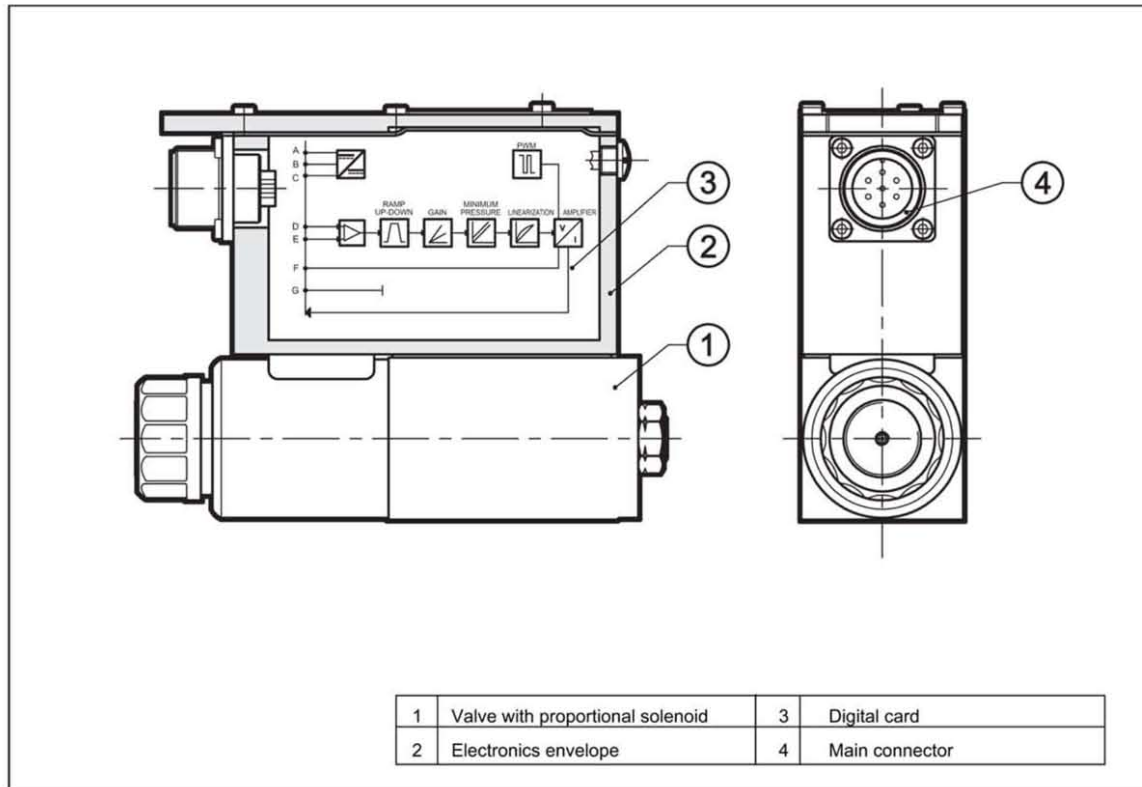

4.3 - Electrical characteristics

NOMINAL VOLTAGE	V DC	24 V DC (from 19 to 35 V DC, ripple max 3 Vpp)
ABSORBED POWER	W	50
MAXIMUM CURRENT	A	1,88
DUTY CYCLE		100%
VOLTAGE SIGNAL (E0)	V DC	0 ÷ 10 (Impedence Ri > 50 KΩ)
CURRENT SIGNAL (E1)	mA	4 ÷ 20 (Impedence Ri = 500 Ω)
ALARMS		Overload and electronics overheating
COMMUNICATION		Interface of the optoisolated industrial Field-bus type CAN-Bus ISO 11898
MAIN CONNECTOR		7 - pin MIL-C-5015-G (DIN 43563)
CAN-BUS CONNECTOR		M12-IEC 60947-5-2
ELECTROMAGNETIC COMPATIBILITY (EMC)		
EMISSIONS	EN 50081-1	according to 89/336 CEE standards
IMMUNITY	EN 50082-2	
PROTECTION AGAINST ATMOSPHERIC AGENTS		IP67 (CEI EN 60529 standards)

PRED3G

SERIES 11

5 - OPERATING MODALITIES

The digital driver of PRED3G valve may be used with different functions and operating modalities, depending on the requested performances.

5.1 - Standard version with voltage reference signal (E0)

This is the most common version; it makes the valve completely interchangeable with the traditional proportional valves with analog type integrated electronics. The valve has only to be connected as indicated below.

This version doesn't allow the setting of the valve parameters, for example the ramps must be performed in the PLC program, as well as the reference signal limit.

Standard connection scheme with voltage reference signal (E0)

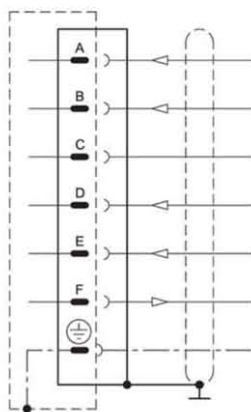

Pin	Values	Function	NOTE
A	24 V DC	Voltage	from 19 to 35V DC (ripple max 3 Vpp)(see NOTE 2)
B	0 V	Power supply (zero)	0 V
C	----	Not used	----
D	0 + 10 V	Input rated command	Impedence $R_i > 50 \text{ k}\Omega$
E	0 V	Input rated command	----
F	0 + 10 V	Test point coil current	$0 + 100\% I_{MAX}$ (see NOTE 1)
PE	GND	Protective ground	----

NOTE: If only one input signal is available (single-end), then the pin B (0V power supply) and the pin E (0V reference signal) must be connected through a jumper and both connected to GND, electric panel side.

5.2 - Standard version with current reference signal (E1)

This version has characteristics which are similar to the previous one, with the difference that in this case the reference signal is supplied in current 4 - 20 mA. With the 4 mA signal the valve is at zero value, while with 20 mA signal the valve is at the maximum setting value.

Standard connection scheme with current reference signal (E1)

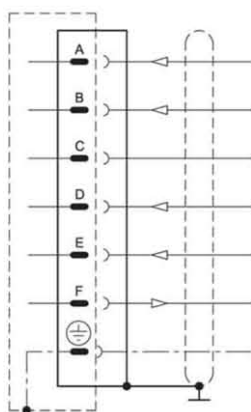

Pin	Values	Function	NOTE
A	24 VDC	Voltage	from 19 to 35V DC (ripple max 3 Vpp)(see NOTE 2)
B	0 V	Power supply (zero)	0 V
C	----	Not used	----
D	4 + 20 mA	Input signal	Impedence $R_i = 500 \Omega$
E	0 V	Zero reference	----
F	0 + 10 V	Test point coil current	$0 + 100\% I_{MAX}$ (see NOTE 1)
PE	GND	Protective ground	----

NOTE for the wiring: connections must be made via the 7-pin plug mounted on the amplifier. Recommended cable sizes are 0,75 mm² for cables up to 20 m and 1,00 mm² for cables up to 40m, for power supply. The signal cables must be 0,50 mm². A suitable cable would have 7 cores, a separate screen for the signal wires and an overall screen.

NOTE 1: Read the test point pin F in relation to pin B (0V)

NOTE 2: Envisage an external fuse on pin A (24V DC) to shield the card. Fuse specifications: 5A/50V fast type.

PRED3G

SERIES 11

5.3 - Version with parameters set by CAN connector (version C)

This version allow to set some parameters of the valve connecting a PC to the CAN connector.

To do this, you have to order the interface device for USB port **CANPC-USB/10** (code 3898101001), complete of the configuration software CANPC-SOF/R001, a communication cable (length 3 mt) and a hardware converter needed to connect the valve to the USB port.

The parameters that can be set are described below:

Nominal pressure

The "nominal pressure" parameter limits the maximum current to the solenoid, therefore it sets the desired nominal pressure corresponding to the positive value of the input reference (10 V or 20 mA).

Default value = 100% of full scale

Range: from 100% to 50% of full scale

PWM Frequency

Sets the PWM frequency, which is the pulsating frequency of the control current. The PWM decrease improves the valve accuracy, decreasing the regulation stability.

The PWM increase improves the regulation stability, causing a higher hysteresis.

Default value = 300 Hz

Range 50 ÷ 500 Hz

Ramps

Increase time of Ramp R1: sets the current increase time for a variation from 0 to 100% of the input reference.

Decrease time of Ramp R2: sets the current decrease time for a variation from 0 to 100% of the input reference.

Min time = 0,001 sec.

Max time = 40,000 sec.

Default time = 0,001 sec.

Diagnostics

Provides several information parameters, such as:

- The electronic driver status (Working or Broken)
- The active regulation
- Input reference
- Current value

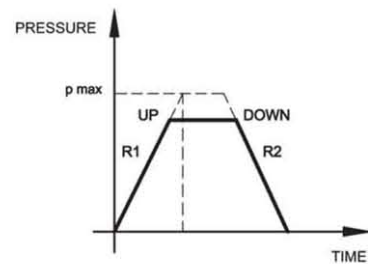
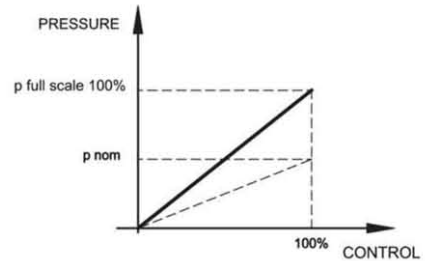

PRED3G

SERIES 11

5.4 - Version with CAN-Bus interface (version C)

This version allows the valve piloting through the industrial field bus CAN-Open, according to ISO 11898 standards.

The CAN connector must be connected (see scheme) as a slave node of the CAN-Open bus, while the main connector is wired only for the power supply (pin A and B + earth)

The most important characteristics of a CAN - Open connection are:

- Parameter storage also in PLC
- Parameters setting in real-time (PDO communication)
- On-line valve diagnostics
- Easy wiring with the serial connection
- Communication program according to international standards

For detailed information on the CAN-Open communication software, see cat. 89 800.

CAN connector connection scheme

Pin	Values	Function
1	CAN_SHLD	monitor
2	CAN +24VDC	BUS + 24 VDC (max 30 mA)
3	CAN 0 DC	BUS 0 VDC
4	CAN_H	BUS line (high signal)
5	CAN_L	BUS line (low signal)

N.B. : insert a 120 Ω resistance on pin 4 and pin 5 of the CAN connector when the valve is the end-knot of the CAN network.

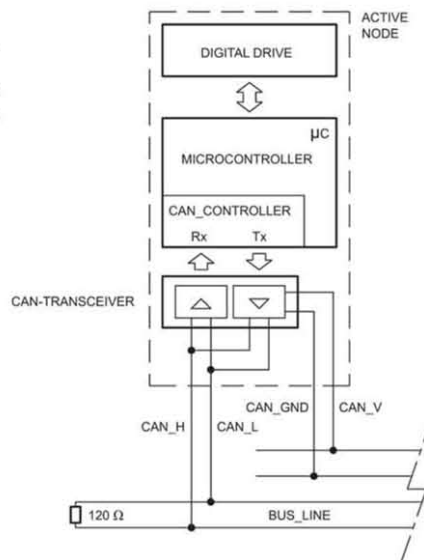

6 - INSTALLATION

We recommend to install the PRED3G valve either in horizontal position, or vertical position with the solenoid downward. If the valve is installed in vertical position and with the solenoid upward, you must consider possible variations of the minimum controlled pressure, if compared to what is indicated in paragraph 2.

Ensure that there is no air in the hydraulic circuit. In particular applications, it can be necessary to vent the air entrapped in the solenoid tube, by using the appropriate drain screw in the solenoid tube. Ensure that the solenoid tube is always filled with oil (see paragraph 8). At the end of the operation, make sure of having correctly replaced the drain screw.

Connect the valve T port directly to the tank. Add any backpressure value detected in the T line to the controlled pressure value. Maximum admissible backpressure in the T line, under operational conditions, is 2 bar.

Valves are fixed by means of screws or tie rods on a flat surface with planarity and roughness equal to or better than those indicated in the relative symbols. If minimum values are not observed, fluid can easily leak between the valve and support surface.

7 - HYDRAULIC FLUIDS

Use mineral oil-based hydraulic fluids HL or HM type, according to ISO 6743-4. For these fluids, use NBR seals. For fluids HFDR type (phosphate esters) use FPM seals (code V). For the use of other kinds of fluid such as HFA, HFB, HFC, please consult our technical department. Using fluids at temperatures higher than 80 °C causes a faster degradation of the fluid and of the seals characteristics. The fluid must be preserved in its physical and chemical characteristics.

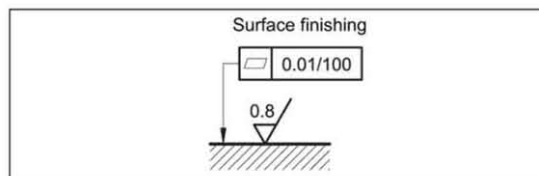

PRED3G

SERIES 11

8 - OVERALL AND MOUNTING DIMENSIONS

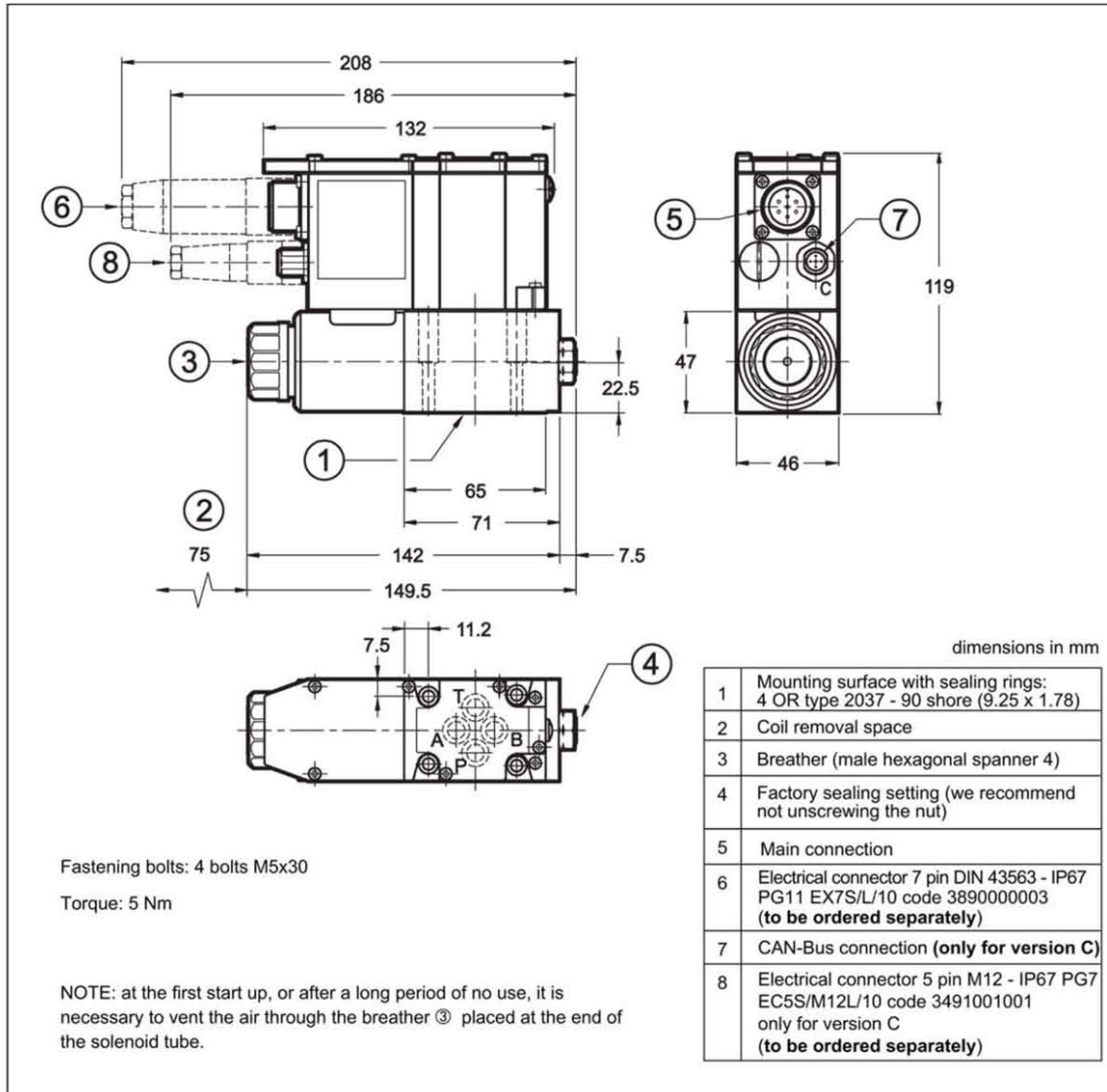

9 - SUBPLATES (See catalogue 51 000)

PMMD-AI3G rear ports
PMMD-AL3G side ports
Ports dimensions: P, T, A, B: 3/8" BSP