

Part number:

097-10012

HYDROMA

HYDRAULICKÉ SYSTÉMY

**HIDROMA
SYSTEMS**

UKŁADY HYDRAULICZNE

HYDROMA

ГИДРАВЛИЧЕСКИЕ СИСТЕМЫ

HYDROSTATIC STEERING UNITS TYPE HKUS.../3, 4, 8



The HKUS Hydrostatic Steering unit is based on the HKU unit but has built-in relief and check valves. Thus M+S Hydraulic achieves one very compact steering unit which reduces the need for additional hydraulic components in the system.

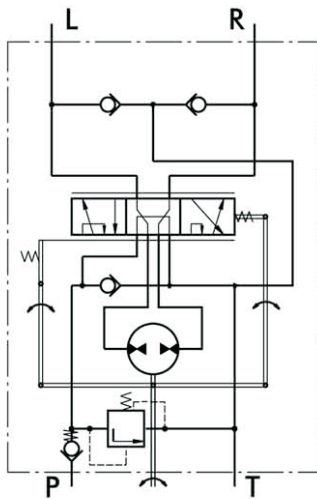

"Open Center - Load Reaction"
With Built-in Valves
Version 3 - HKUS.../3

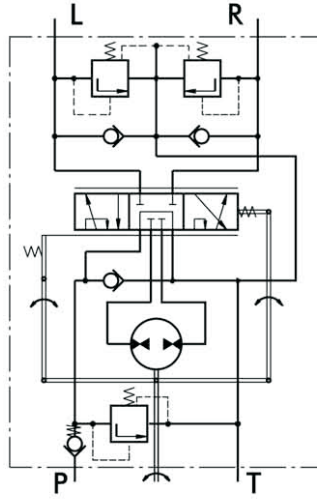

"Open Center - Non Load Reaction"
With Built-in Valves
Version 4 - HKUS.../4

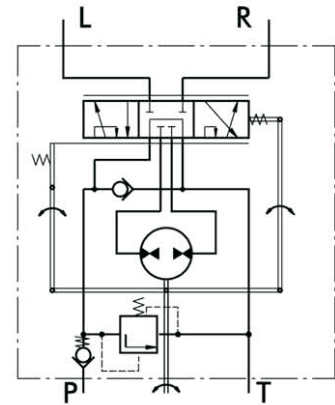

"Open Center - Non Load Reaction"
With Built-in Valve
Version 8 - HKUS.../8

SPECIFICATION DATA

Parameters	Type											
	HKUS 40/3,4,8	HKUS 50/3,4,8	HKUS 63/3,4,8	HKUS 80/3,4,8	HKUS 100/3,4,8	HKUS 125/3,4,8	HKUS 160/3,4,8	HKUS 200/3,4,8	HKUS 250/3,4,8	HKUS 320/3,4,8	HKUS 400/3,4,8	
Displacement [cm ³ /rev]	39,6	49,5	65,6	79,2	99,0	123,8	158,4	198	247,5	316,8	396	
Rated Flow* [l/min]	4	5	6	8	10	13	16	20	25	32	40	
Rated Pressure [bar]	160											
Relief Valve Pressure Settings** [bar]				80	100	125	150					
Shock Valves Pressure Settings*** [bar]				140	160	180	200					
Max.Cont. Pressure in Line T - P _T [bar]	25 (50 - for HKUS.../8)											
Max.Torque at Servoamplifying [Nm]	6 (by P _{T,max})											
Max.Torque w/o Servoamplifying [Nm]	120											
Weight, avg. [kg]	5,3	5,5	5,6	5,7	5,8	5,9	6,2	6,5	6,6	7,2	7,8	
Dimension A [mm]	130,8	132,2	133,9	136,2	138,8	142,2	146,8	152,2	158,8	168,2	178,8	

* Rated Flow at 100 RPM.

** Pressure Settings are at Rated Flow (as in the table) and viscosity 21 mm²/s (50° C).

***Pressure Settings are at flow rate of 2 l/min and viscosity 21 mm²/s (50° C).

ORDER CODE

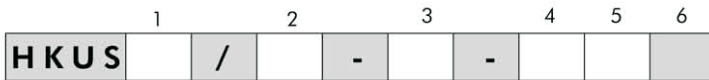

Pos.1 - Displacement code (see Specification Data)

40	- 39,6 [cm ³ /rev]
50	- 49,5 [cm ³ /rev]
63	- 65,6 [cm ³ /rev]
80	- 79,2 [cm ³ /rev]
100	- 99,0 [cm ³ /rev]
125	- 123,8 [cm ³ /rev]
160	- 158,4 [cm ³ /rev]
200	- 198,0 [cm ³ /rev]
250	- 247,5 [cm ³ /rev]
320	- 316,8 [cm ³ /rev]
400	- 396,0 [cm ³ /rev]

Pos.2 - Versions

3	- Version 3 "Open Center - Load Reaction"
4	- Version 4 "Open Center - Non Load Reaction"
8	- Version 8 "Open Center - Non Load Reaction"

Pos.3 - Relief Valve Pressure Settings, bar

80
100
125
150

Pos.4 - Ports

omit	- BSPP (ISO 228)
A	- SAE (ANSI B 1.1 - 1982)
M	- Metric (ISO 262)

Pos.5 - Option (Paint)*

omit	- No Paint
P	- Painted
PC	- Corrosion Protected Paint

Pos.6 - Design Series

omit	- Factory specified
------	---------------------

Version	Manual Steering Check Valve	Relief Valve	Inlet Check Valve	Cylinder Relief Valve	Anti-Cavitation Valve
3	•	•	•		•
4	•	•	•	•	•
8	•	•	•		

NOTES:

* Colour at customer's request.

The steering units are mangano-phosphatized as standard.

SPECIFICATION DATA

Parameters	Type													
	HKU 40/5T	HKU 50/5T	HKU 63/5T	HKU 80/5T	HKU 100/5T	HKU 125/5T	HKU 160/5T	HKU 200/5T	HKU 250/5T	HKU 320/5T	HKU 400/5T	HKU 500/5T	HKU 630/5T	
	HKUS 40/5...	HKUS 50/5...	HKUS 63/5...	HKUS 80/5...	HKUS 100/5...	HKUS 125/5...	HKUS 160/5...	HKUS 200/5...	HKUS 250/5...	HKUS 320/5...	HKUS 400/5...			
Displacement [cm ³ /rev]	39,6	49,5	65,6	79,2	99,0	123,8	158,4	198	247,5	316,8	396	495	618,7	
Rated Flow* [l/min]	4	5	6	8	10	13	16	20	25	32	40	50	63	
Rated Pressure [bar]	125	150	175											
LS - Valve Pressure Settings** [bar]				80	100	125	150	175						
Shock Valves Pressure Settings*** [bar]				140	160	180	200	240						
Max.Cont. Pressure in Line T - P _T [bar]	20													
Max.Torque at Servoamplifying [Nm]	6 (by P _T max)													
Max.Torque w/o Servoamplifying [Nm]	120													
Weight, avg. [kg]	5,4	5,5	5,6	5,7	5,8	5,9	6,2	6,5	6,6	7,2	7,8	8	8,7	
Dimension A [mm]	130,8	132,2	133,9	136,2	138,8	142,2	146,8	152,2	158,8	168,2	178,8	192	209,3	

* Rated Flow at 100 RPM.

** Pressure Settings are at flow rate of 6 l/min and viscosity 21 mm²/s (50° C).

*** Pressure Settings are at flow rate of 2 l/min and viscosity 21 mm²/s (50° C).

DIMENSIONS AND MOUNTING DATA - HKUS.../5

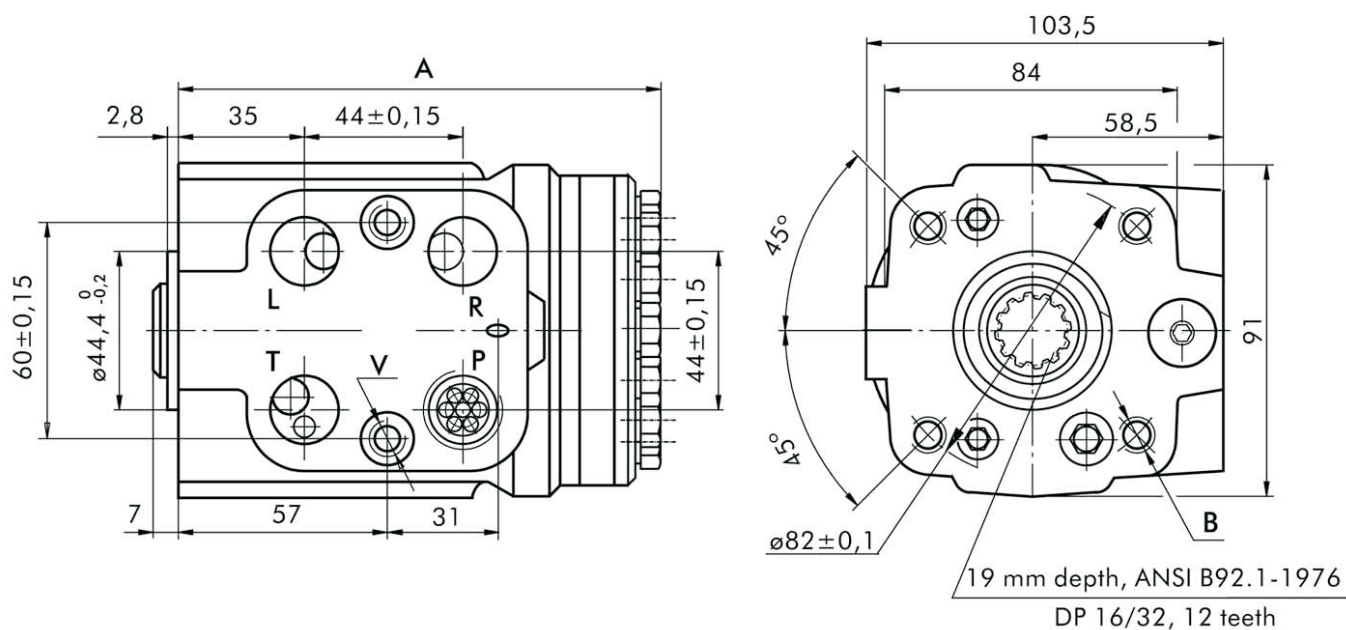

STEERING UNITS

ORDER CODE for HKUS.../5...

	1		2		3		4		5		6		7		8
HKUS		/	5					-		-					

Pos.1 - Displacement code (see Specification Data)

40	- 39,6 [cm ³ /rev]
50	- 49,5 [cm ³ /rev]
63	- 65,6 [cm ³ /rev]
80	- 79,2 [cm ³ /rev]
100	- 99,0 [cm ³ /rev]
125	- 123,8 [cm ³ /rev]
160	- 158,4 [cm ³ /rev]
200	- 198,0 [cm ³ /rev]
250	- 247,5 [cm ³ /rev]
320	- 316,8 [cm ³ /rev]
400	- 396,0 [cm ³ /rev]

Pos.2 - Versions

5	- Version 5 "Closed Center - Non Reaction and Load Sensing Outlet"
----------	--

Pos.3 - Priority Valve Connection

omit	- Modularity Mounting
T	- Pipe Mounting

Pos.4 - Electric Signal Connection

omit	- without electric signal connection
E	- with electric signal connection

Pos.5 - LS - Valve Pressure Settings, bar

80	100	125	150	175
-----------	------------	------------	------------	------------

Pos.6 - Ports

omit	- BSPP (ISO 228)
A	- SAE (ANSI B 1.1 - 1982)
M	- Metric (ISO 262)

Pos.7 - Option (Paint)*

omit	- No Paint
P	- Painted
PC	- Corrosion Protected Paint

Pos.8 - Design Series

omit	- Factory specified
------	---------------------

NOTES:

* Colour at customer's request.
The steering units are mangano-phosphatized as standard.

ORDER CODE for HKU.../5T...

	1		2		3		4		5		6
HKU		/	5	T		-					

Pos.1 - Displacement code (see Specification Data)

40	- 39,6 [cm ³ /rev]
50	- 49,5 [cm ³ /rev]
63	- 65,6 [cm ³ /rev]
80	- 79,2 [cm ³ /rev]
100	- 99,0 [cm ³ /rev]
125	- 123,8 [cm ³ /rev]
160	- 158,4 [cm ³ /rev]
200	- 198,0 [cm ³ /rev]
250	- 247,5 [cm ³ /rev]
320	- 316,8 [cm ³ /rev]
400	- 396,0 [cm ³ /rev]
500	- 495,0 [cm ³ /rev]
630	- 618,7 [cm ³ /rev]

Pos.2 - Versions

5	- Version 5 "Closed Center - Non Reaction and Load Sensing Outlet"
----------	--

Pos.3 - Priority Valve Connection

T	- Pipe Mounting
----------	-----------------

Pos.4 - Ports

omit	- BSPP (ISO 228)
A	- SAE (ANSI B 1.1 - 1982)
M	- Metric (ISO 262)

Pos.5 - Option (Paint)*

omit	- No Paint
P	- Painted
PC	- Corrosion Protected Paint

Pos.6 - Design Series

omit	- Factory specified
------	---------------------

NOTES:

* Colour at customer's request.
The steering units are mangano-phosphatized as standard.

PRIORITY VALVES FOR HKUS.../5... TYPE PR...

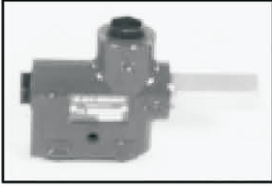
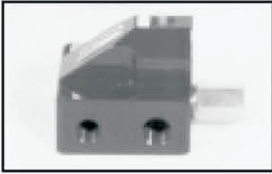

The Priority Valves distribute and trace the hydraulic flow from the supply pump of the hydraulic system to the hydraulic components which control and run the vehicle.

The Priority Valves are used only with the HKUS.../5(E)(T)(TE) hydrostatic steering units. When connected, the steering unit and the priority valve represent sophisticated hydraulic tracing system that controls the flow in both main pipelines of the hydraulic system (the working and control one) at any time of its operation.

As a static signal, the "LS" signal must be used in systems with circuit stability. The connection between the PRT, PRTA priority valves and the HKUS.../5T(TE) steering units has to be as short as possible, but should not exceed 1,5m (for iron pipe with $\varnothing 4$

Modulary Mounting

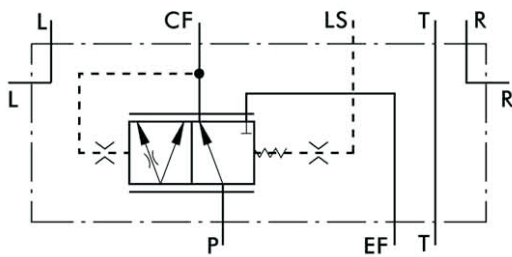

Static signal
PRD.../40,80...

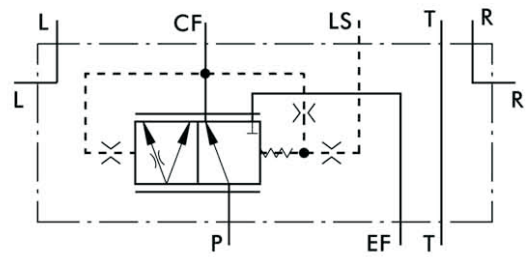

Dinamic signal
PRDD.../40,80...

Pipe Mounting

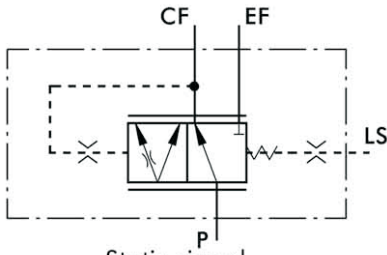

Static signal
PRT.../40,80...; PRTA.../40,80...

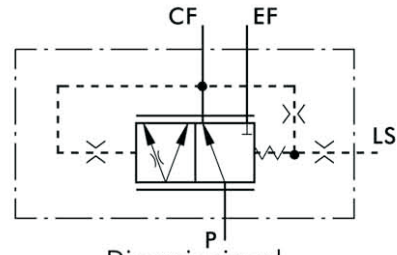

Dinamic signal
PRTD.../40,80...; PRTAD.../40,80...

PR...40

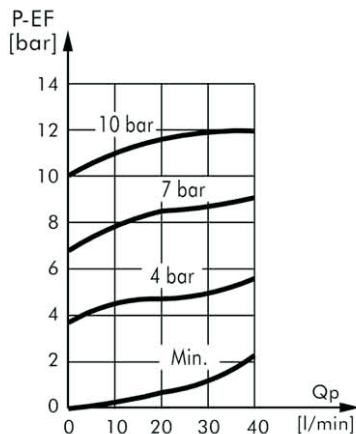

PR...80

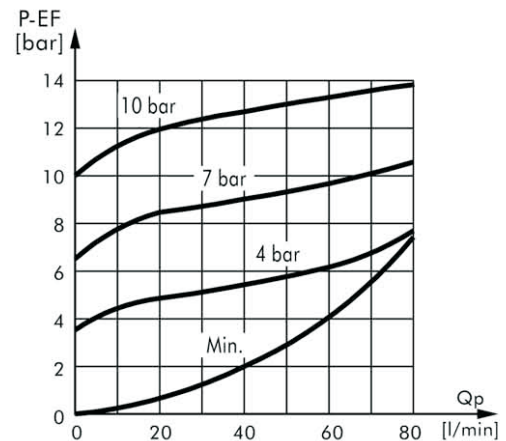

SPECIFICATION DATA

Parameters		Type					
		PRD(D), PRT(D)			PRTA(D)		
Rated Flow	[l/min]	40; 80					
Control Spring Pressure	[bar]	4	7	10	4	7	10
Max. Pressures in Oil Ports: P, EF, R, L	[bar]	250					
	LS, CF	175					
	T	20					
Weight, avg.	[kg]	2,7			1,2		

P - pump, **EF** - excess flow, **CF** - control flow (first priority oil flow),
L - left, **R** - right, **LS** - load sensing, **T** - tank

DIMENSIONS AND MOUNTING DATA - PRD(D)/ 40,80

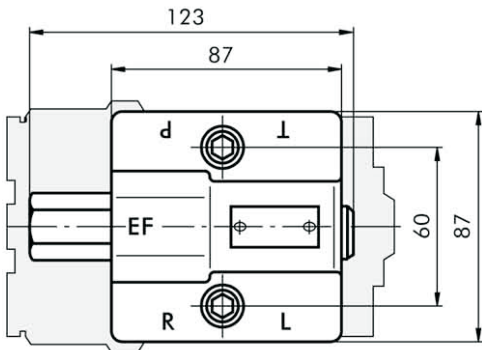
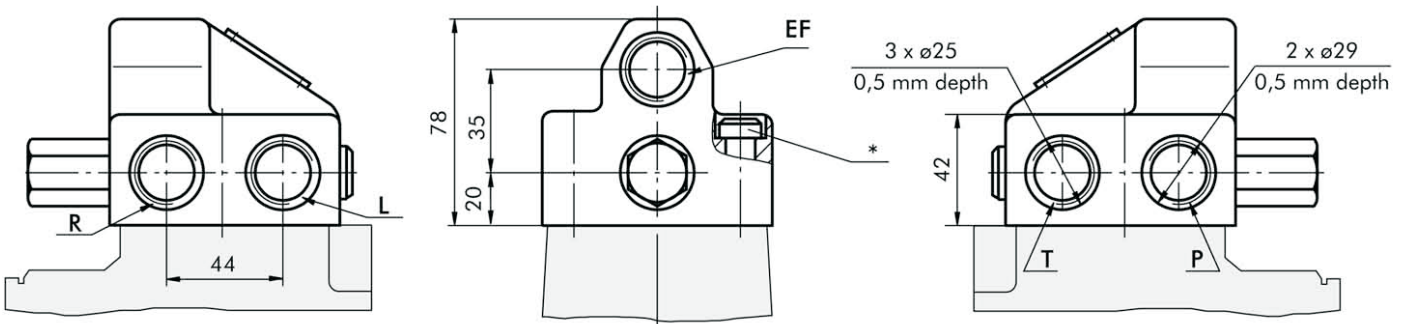

code	Ports - P, EF Thread	Ports - T, R, L Thread
-	G1/2 18 mm depth	G3/8 18 mm depth
M	M22x1,5 18 mm depth	M18x1,5 18 mm depth
A	7/8 - 14 UNF O-ring 18 mm depth	3/4 - 16 UNF O-ring 18 mm depth

* Connection to the HKUS.../5... is done with 2 screws M10x1x45-10.9 DIN 912 or with 2 screws 3/8-24 UNF ANSI B18.3-76; 44,5 mm long.
Tightening torque: 4,5±0,5 daNm.

DIMENSIONS AND MOUNTING DATA - PRT(D)/40,80

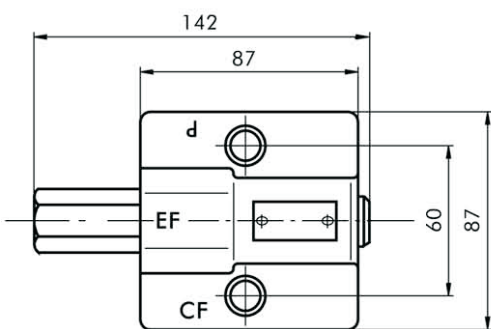
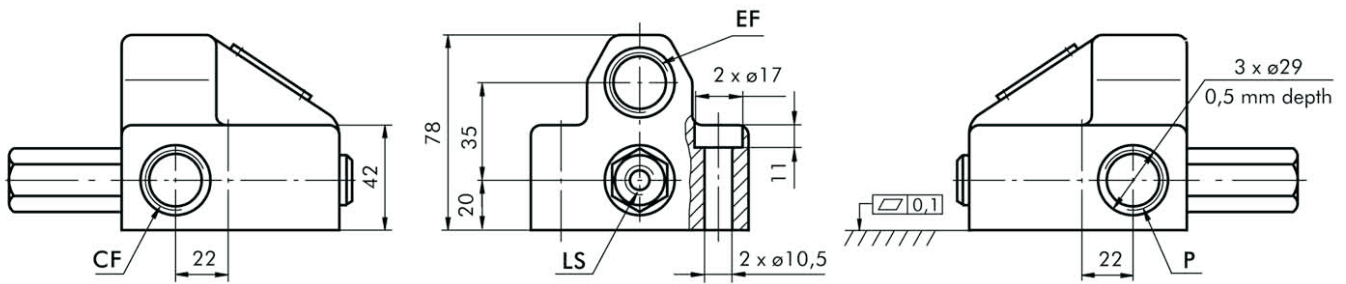

code	Ports - P, EF Thread	Port - CF Thread	LS - Port
-	G1/2 18 mm depth	G1/2 18 mm depth	G1/4 14 mm depth
M	M22x1,5 18 mm depth	M22x1,5 18 mm depth	G1/4 14 mm depth
A	7/8 - 14 UNF O-ring 18 mm depth	3/4 - 16 UNF O-ring 18 mm depth	7/16 - 20 UNF O-ring 12,7 mm depth

DIMENSIONS AND MOUNTING DATA - PRTA(D)/40,80

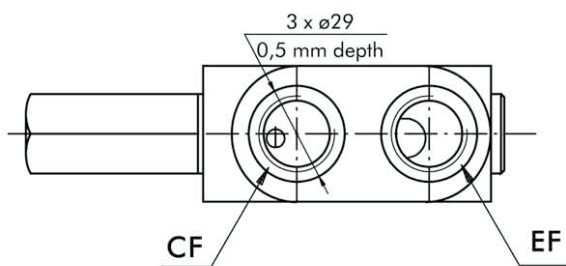
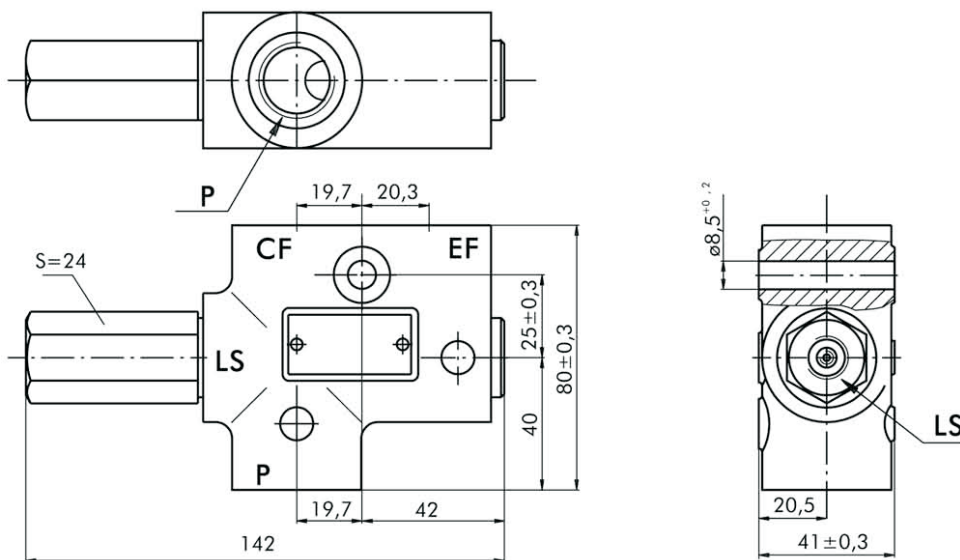

code	Ports - P, EF Thread	Port - CF Thread	LS - Port
-	G1/2 18 mm depth	G1/2 18 mm depth	G1/4 14 mm depth
M	M22x1,5 18 mm depth	M22x1,5 18 mm depth	G1/4 14 mm depth
A	7/8 - 14 UNF O-ring 18 mm depth	3/4 - 16 UNF O-ring 18 mm depth	7/16 - 20 UNF O-ring 12,7 mm depth