

Part number:

020-10013

HYDROMA

HYDRAULICKÉ SYSTÉMY

**HIDROMA
SYSTEMS**

UKŁADY HYDRAULICZNE

HYDROMA

ГИДРАВЛИЧЕСКИЕ СИСТЕМЫ

Miniprese prova pressione

Test couplings for pressure checking

Adattatori per manometro
Pressure gauge adapters

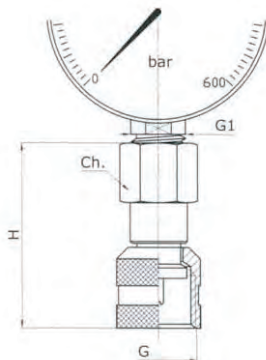

Porta manometro connessione diretta
Direct gauge adapter

G	G1	H	Ch	Ch1	PN bar	Codice / Ref.
M 16x2	ISO 228 G 1/4"	50	19	19	630	20140000
M 16x2	ISO 228 G 1/2"	55	27	19	630	20120000
M 16x1,5	ISO 228 G 1/4"	50	19	19	630	20141500
M 16x1,5	ISO 228 G 1/2"	55	27	19	630	20121500

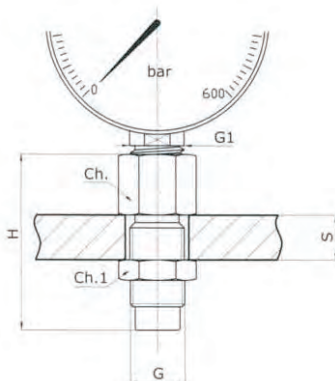

Porta manometro passaparete
Bulkhead pressure gauge connection

G	G1	H	Ch	Ch1	S max	PN bar	Codice / Ref.
M 16x2	ISO 228 G 1/4"	50	19	19	11	630	18140000
M 16x2	ISO 228 G 1/2"	57	27	19	13	630	18120000
M 16x1,5	ISO 228 G 1/4"	50	19	19	11	630	18141500
M 16x1,5	ISO 228 G 1/2"	57	27	19	13	630	18121500

Smorzatore di pressione a richiesta: aggiungere S nel codice.

Pressure damper on request: add S in the ref.

nota: passaggio libero senza valvola

note: without check valve

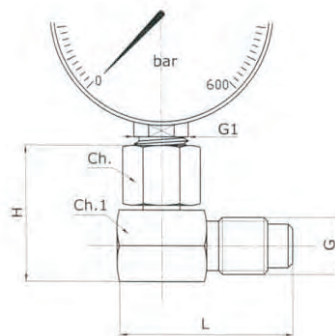

Porta manometro orientabile 90°
Swivel pressure gauge connection 90° angle

G	G1	H	L	Ch	Ch1	PN bar	Codice / Ref.
M 16x2	ISO 228 G 1/4"	36	42	19	19	630	21140000
M 16x2	ISO 228 G 1/2"	43	42	27	19	630	21120000
M 16x1,5	ISO 228 G 1/4"	36	42	19	19	630	21141500
M 16x1,5	ISO 228 G 1/2"	43	42	27	19	630	21121500

Smorzatore di pressione a richiesta: aggiungere S nel codice

Pressure damper on request: add S in the ref.

nota: passaggio libero senza valvola

note: without check valve