

Part number:

HYDROMA
HYDRAULICKÉ SYSTÉMY

HIDROMA
SISTEMS
UKŁADY HYDRAULICZNE

HYDROMA
ГИДРАВЛИЧЕСКИЕ СИСТЕМЫ

FPH-TLM

PRESSURE FILTERS

MATERIALS

Head: Aluminium alloy
Bowl: Steel
Bypass valve: Polyamide
Seals: NBR Nitrile
Indicator housing: Brass

PRESSURE

Max working: 2 MPa (20 bar)
Collapse, differential for the filter element (ISO 2941):
300 kPa (3 bar)

BYPASS VALVE

Setting: 170 kPa (1,7 bar) \pm 10%

WORKING TEMPERATURE

From -25° to +110° C

COMPATIBILITY (ISO 2943)

Full with fluids: HH-HL-HM-HV-HTG
(according to ISO 6743/4)
For fluids different than the above mentioned,
please contact our Customer Service.

HYDRAULIC DIAGRAM

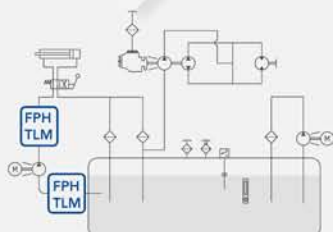

FPH

PRESSURE FILTERS

ORDERING AND OPTION CHART

F	P	H	COMPLETE FILTER FAMILY					FILTER ELEMENT FAMILY	E	R	A
			SIZE & LENGTH	31	40	50	52	SIZE & LENGTH			
			PORT TYPE								
			B = BSP thread	B	B	B	B				
			N = NPT thread	N	N	N	N				
			PORT SIZE								
			03 = 3/8"	03	-	-	-				
			04 = 1/2"	04	-	-	-				
			06 = 3/4"	-	06	-	-				
			08 = 1"	-	08	-	-				
			10 = 1" 1/4	-	-	10					
			12 = 1" 1/2	-	-	-	12				
		B	BYPASS VALVE								
			B = 170 kPa (1,7 bar)	B	B	B	B				
			SEALS					SEALS			
			N = NBR Nitrile	N	N	N	N				
			F = FKM Fluoroelastomer	F	F	F	F				
			FILTER MEDIA					FILTER MEDIA			
			FA = fibreglass 5 µm(c) β>1.000	FA	FA	FA	FA				
			FB = fibreglass 7 µm(c) β>1.000	FB	FB	FB	FB				
			FC = fibreglass 12 µm(c) β>1.000	FC	FC	FC	FC				
			FS = fibreglass 16 µm(c) β>1.000	FS	FS	FS	FS				
			FD = fibreglass 21 µm(c) β>1.000	FD	FD	FD	FD				
			FE = fibreglass 30 µm(c) β>1.000	FE	FE	FE	FE				
			ME = metal wire mesh 60 µm	ME	ME	ME	ME				
			MF = metal wire mesh 90 µm	MF	MF	MF	MF				
			CLOGGING INDICATOR**								
			03 = port, plugged	03	03	03	03				
			5B = visual differential 130 kPa (1,3 bar)	5B	5B	5B	5B				
			6B = electrical differential 130 kPa (1,3 bar)	6B	6B	6B	6B				
			7B = indicator 6B with LED	7B	7B	7B	7B				
			T0 = elect. diff. 130 kPa (1,3 bar) with thermostat 30°C	T0	T0	T0	T0				
			0R = 1/8" predisposition	0R	0R	0R	0R				
			31 = pressure gauge, rear connection	31	31	31	31				
			P1 = SPDT, pressure switch	P1	P1	P1	P1				
			10 = vacuum gauge	10	10	10	10				
			91 = vacuum switch	91	91	91	91				
X	X		ACCESSORIES								
			XX = no accessory available	XX	XX	XX	XX				

TLM

PRESSURE FILTERS

ORDERING AND OPTION CHART

T	L	M	COMPLETE FILTER FAMILY					FILTER ELEMENT FAMILY	C	R	E
			SIZE & LENGTH	019	055	115	150	SIZE & LENGTH			
				015	048	058	100				
			FILTER MEDIA					FILTER MEDIA			
			FT = fibreglass 5 µm(c) β>1.000	FT	FT	FT	FT				
			FC = fibreglass 7 µm(c) β>1.000	FC	FC	FC	FC				
			FD = fibreglass 12 µm(c) β>1.000	FD	FD	FD	FD				
			FS = fibreglass 16 µm(c) β>1.000	FS	FS	FS	FS				
			FV = fibreglass 21 µm(c) β>1.000	FV	FV	FV	FV				
			MS = metal wire mesh 60 µm	MS	MS	MS	MS				
			MN = metal wire mesh 90 µm	MN	MN	MN	MN				
			SEALS					SEALS			
			1 = NBR Nitrile	1	1	1	1				
			2 = FKM Fluoroelastomer	2	2	2	2				
B			BYPASS VALVE								
			B = 170 kPa (1,7 bar)	B	B	B	B				
			PORT TYPE								
			B = BSP thread	B	B	B	B				
			N = NPT thread	N	N	N	N				
			PORT SIZE								
			2 = 3/8"	2	-	-	-				
			3 = 1/2"	3	-	-	-				
			4 = 3/4"	-	4	-	-				
			5 = 1"	-	5	-	-				
			6 = 1" 1/4	-	-	6	-				
			7 = 1" 1/2	-	-	-	7				
			CLOGGING INDICATOR**								
			03 = port, plugged	03	03	03	03				
			5B = visual differential 130 kPa (1,3 bar)	5B	5B	5B	5B				
			6B = electrical differential 130 kPa (1,3 bar)	6B	6B	6B	6B				
			7B = indicator 6B with LED	7B	7B	7B	7B				
			T0 = elect. diff. 130 kPa (1,3 bar) with thermostat 30°C	T0	T0	T0	T0				
			0R = 1/8" predisposition	0R	0R	0R	0R				
			31 = pressure gauge, rear connection	31	31	31	31				
			P1 = SPDT, pressure switch	P1	P1	P1	P1				
			10 = vacuum gauge	10	10	10	10				
			91 = vacuum switch	91	91	91	91				
X	X		ACCESSORIES								
			XX = no accessory available	XX	XX	XX	XX				

NOTE

** When the filter is ordered with FKM seals, the first digit of the indicator code is a letter (please see Clogging Indicator Chapter for further details)

FPH-TLM

PRESSURE FILTERS

SPARE PARTS ELEMENTS

FILTER HOUSING	FILTER ELEMENT	CLOGGING INDICATOR
		
B P H <input type="text"/> <input type="text"/> B <input type="checkbox"/> <input type="checkbox"/> X X	E R A <input type="text"/> <input type="text"/> <input type="text"/> <input type="text"/>	<input type="text"/> <input type="text"/>

INSTALLATION DRAWING

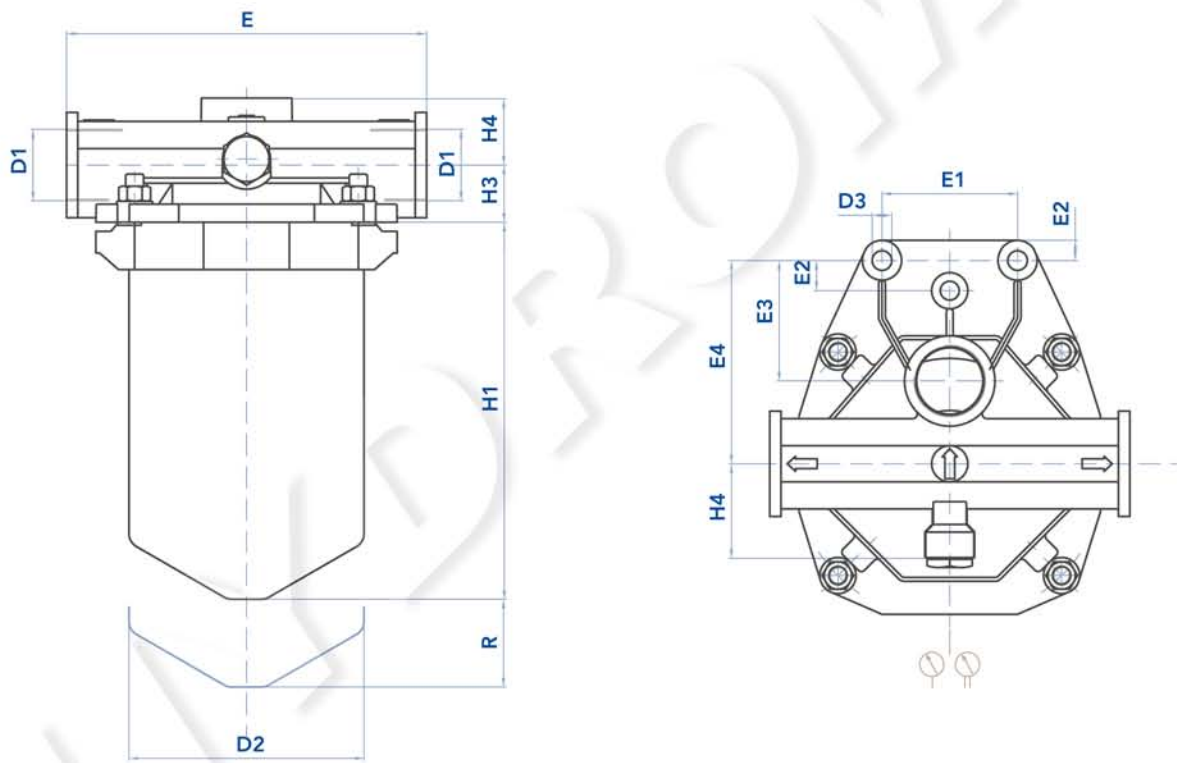

FILTER HOUSING

	D1	D2	D3	E	E1	E2	E3	E4	E5	E6	H1	H2	H3	H4	R	Kg
FPH31 TLM019	3/8" - 1/2"	81	8,5	114	50	-	42	70	15	10	114	44	19	27	20	1,3
FPH40 TLM055	3/4" - 1"	114	10,5	150	50	-	50	85	12	13	204	58	30	35	20	3,2
FPH50 TLM115	1"1/4	156	13	240	90	20	80	135	56	13	180	62	38	45	25	6,1
FPH52 TLM150	1"1/2	156	13	240	90	20	80	135	56	13	250	62	38	45	25	6,8

MAINTENANCE

The best time to change your filter element is just before it reaches its maximum dirt-holding capacity. For this reason, we recommend to monitor the pressure of the hydraulic oil flowing through the filter with a clogging indicator. When it is time to change the filter element, switch off the system before opening the filter housing and make sure there is no pressure in the filter.

Unscrew the nuts and remove the inferior flange and the bowl. Remove the dirty filter element and hold the spring (do not throw it away). Replace the element with an original UFI, verifying the part number on

the filter label or on the catalogue. Insert the clean element into his seat, handling with care and cleanliness. Check the gasket condition and replace if necessary. Place the spring on the bottom of the bowl. Place the bowl in contact with the head gasket. Place the inferior flange and screw the upper nuts until the bowl is completely locked on the head ensuring the seal.

We recommend the stocking of a spare UFI filter element for timely replacement when required.



FILTER ELEMENT

	A	B	C	Kg	AREA (cm ²)	
					Media F+	Media M+
ERA31 CRE015	70	28	93	0,20	620	450
ERA40 CRE048	99	40	178	0,60	3.630	1.690
ERA50 CRE058	130	63	148	1,00	4.450	1.830
ERA52 CRE100	130	63	208	1,35	6.190	2.735

The used filter elements cannot be cleaned and are classified as "Dangerous waste material". They must be disposed according to local laws by authorized Companies.

Verify that the Company you choose has the expertise and authorization to dispose this type of waste material.

FPH-TLM

PRESSURE FILTERS

PRESSURE DROP CURVES (Δp)

The "Assembly Pressure Drop (Δp)" is obtained by adding the pressure drop values of the Filter Housing and

of the Clean Filter Element corresponding to the considered Flow Rate and it must be lower than 50 kPa (0,5 bar).

FILTER HOUSING PRESSURE DROP
(mainly depending on the port size)

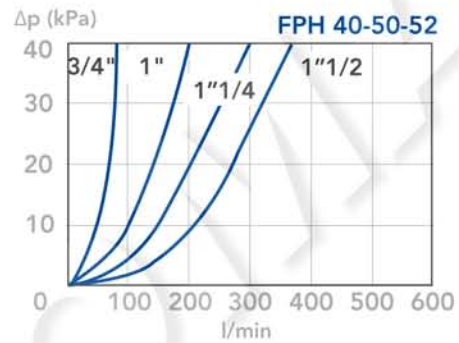
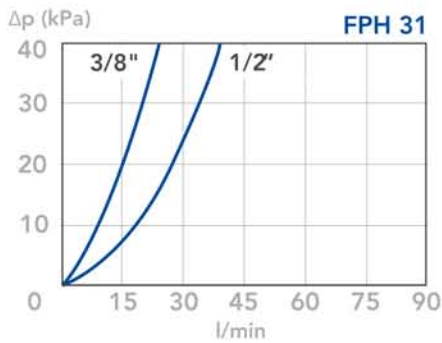

CLEAN FILTER ELEMENT PRESSURE DROP WITH F+ MEDIA
(depending both on the internal diameter of the element and on the filter media)

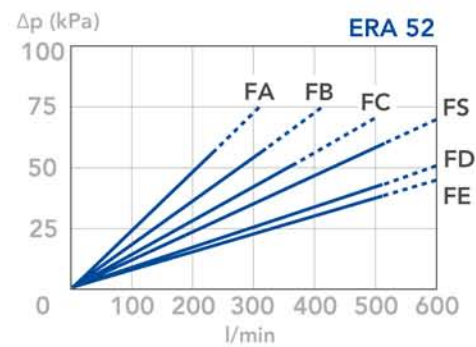
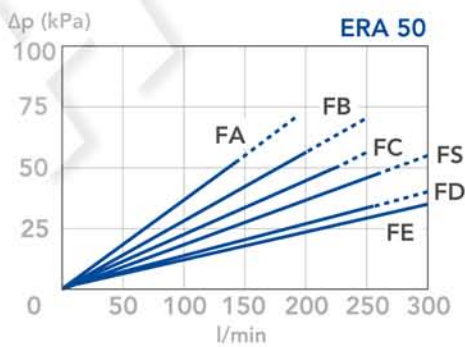
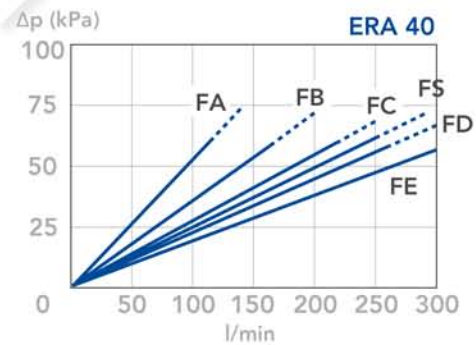
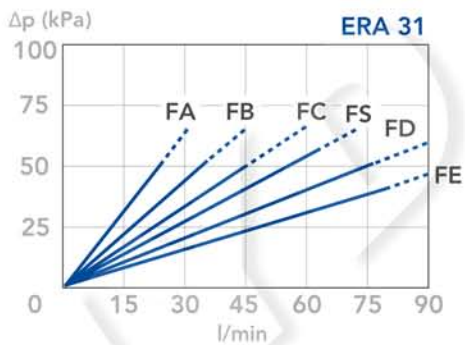

BYPASS VALVE PRESSURE DROP

When selecting the filter size, these curves must be taken into account if it is foreseen that any flow peak is to be absorbed by the bypass valve, it also must be of proper configuration to avoid pressure peaks. The valve pressure drop is directly proportional to fluid specific gravity.

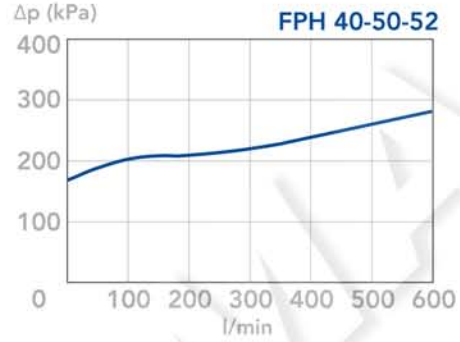
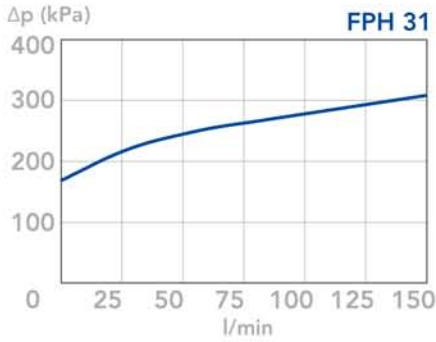

CLEAN FILTER ELEMENT PRESSURE DROP WITH C+ AND M+ MEDIA
(depending both on the internal diameter of the element and on the filter media)

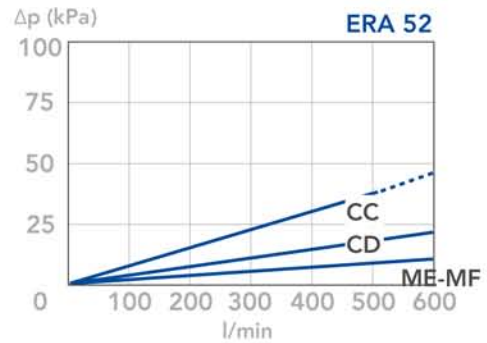
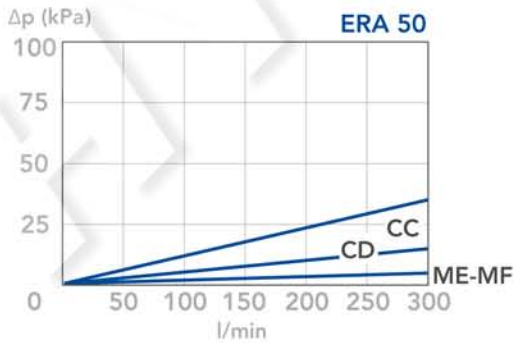
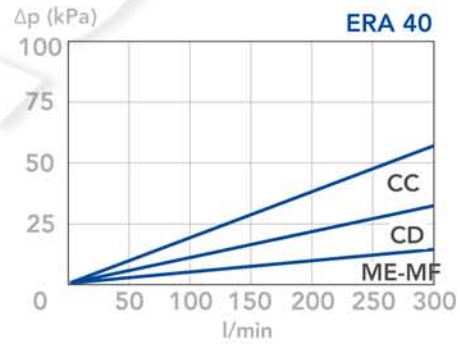
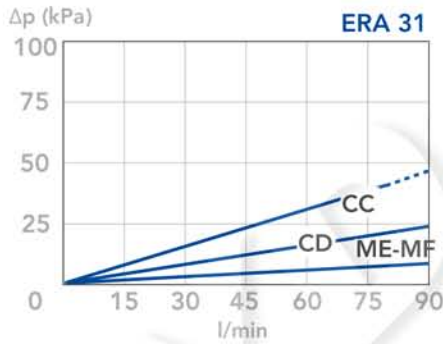

N.B.

All the curves have been obtained with mineral oil having a kinematic viscosity 30 cSt and specific gravity 0,86 Kg/dm³; for fluids with different features, please consider the factors described in the first part of this catalogue. All the curves

are obtained from test done at the UFI HYDRAULIC DIVISION Laboratory, according to the specification ISO 3968. In case of discrepancy, please check the contamination level, viscosity and features of the fluid in use.

FPH-TLM

PRESSURE FILTERS

BYPASS VALVE PRESSURE DROP

When selecting the filter size, these curves must be taken into account if it is foreseen that any flow peak is to be absorbed by the bypass valve, it also must be of proper configuration to avoid pressure peaks. The valve pressure drop is directly proportional to fluid specific gravity.

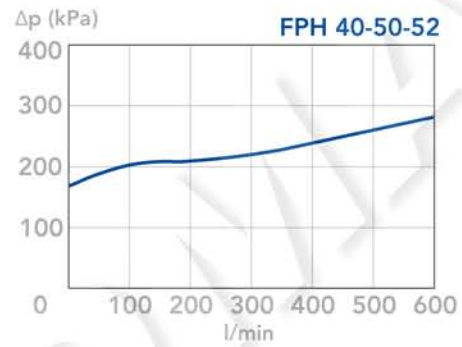
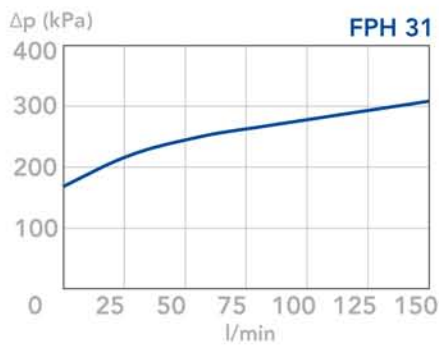

N.B.

All the curves have been obtained with mineral oil having a kinematic viscosity 30 cSt and specific gravity 0,86 Kg/dm³; for fluids with different features, please consider the factors described in the first part of this catalogue. All the curves

are obtained from test done at the UFI HYDRAULIC DIVISION Laboratory, according to the specification ISO 3968. In case of discrepancy, please check the contamination level, viscosity and features of the fluid in use.