

Part number:



HYDROMA

HYDRAULICKÉ SYSTÉMY

**HIDROMA
SISTEMS**

UKŁADY HYDRAULICZNE

HYDROMA

ГИДРАВЛИЧЕСКИЕ СИСТЕМЫ

Solenoid operated valves pilot operated poppet type
2-way normally closed
Common cavity, Size 08

VEI-16-08A-NC

OD.15 - X - 18 - Y - Z

RE 18323-25

Edition: 04.2018

Replaces: 02.2018



PATENT PENDING

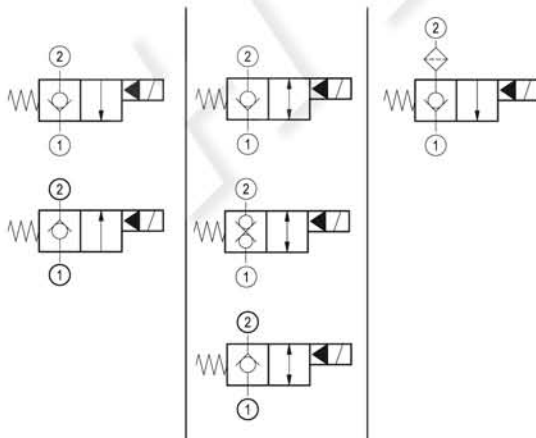
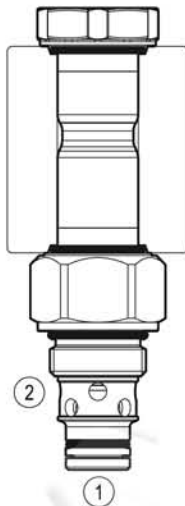

Technical data

New VEI-16 family incorporates a new solenoid concept providing excellent performance and enables cartridges to work in severe environment. Cartridges also incorporates advanced design of hydraulic parts providing excellent hydraulic performance.

Technical data

General		
Weight		0.15 kg (0.33 lbs)
Installation orientation		Unrestricted
Ambient temperature range		-30 to 90 °C (-22 to 194 °F)
Hydraulic		
Max. operating pressure		350 bar (5000 psi)
Flow range		0.5 - 40 l/min (0.1 - 11 gpm)
Fatigue cycle life		2 million cycles at 350 bar 150000 cycles at 420 bar
Max. internal leakage:		5 drops/min. for X= 01,05,07 20 drops/min. for X= 31,03,09
Switching time		Opening ≤ 50 ms
		Closing ≤ 100 ms
Fluid temperature range		-20 to 80 °C (-4 to 176 °F)
Fluids: Mineral-based or synthetics with lubricating properties at viscosities of 20 to 380 mm ² /s (cSt)		
Installation torque		39 - 51 Nm (29 - 38 ft-lbs)
Recommended degree of fluid contamination		Nominal value max. 10 µm (NAS 8) ISO 4406 19/17/14
MTTFd		150 years see RE 18350-51
Cavity		CA-08A-2N see 18325-70
Seal kit for X=01,05,07	code	RG08A2010520100
	material no.	R901101437
Seal kit for X=31,03,09	code	RG08A2010530100
	material no.	R901101544
Seal kit coil and standard cap	code	RG02Z0010000100
	material no.	R930067869
Seal kit coil and protective cap only for Y=D	code	RG03Z0010000100
	material no.	R930067870
Other technical data		See data sheet 18350-50
Electrical		
Type of voltage		DC voltage
Coil type		D36
Supply voltage		See data sheet 18325-90
Voltage tolerance against ambient temperature		See characteristic curve
Power consumption		20 W
Type of protection		See data sheet 18325-90
Note: Coils must be ordered separately		

Ordering code

OD.15	X	18	Y	Z	0000	*
--------------	----------	-----------	----------	----------	-------------	----------

Solenoid operated valves
pilot operated poppet type
2-way normally closed

monodirectional type

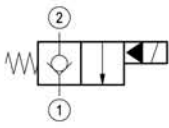

01

bidirectional type

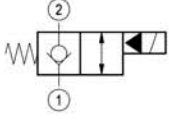

05

monodirectional type with filter

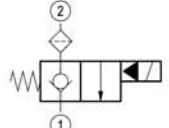

07

bidirectional type

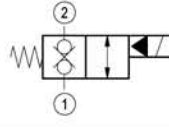

31

bidirectional type

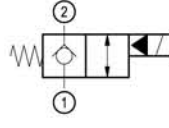

03

monodirectional type

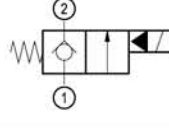

09

Series O/A to L
unchanged performances and dimensions

0 = With buna seal
8 = With buna seal and extra spring only for **03, 05, 31**
V = With Viton seal
P = With buna seal and protective cap for override version **D**
T = With Viton seal and protective cap for override version **D**

A = Standard
D = Knob style manual override
E = Pull style manual override
F = Hand operated pull style manual override

Common cavity: CA-08A-2N

Preferred types

Type	Material number
OD150118A000000	R930058697
OD150118D000000	R930059941
OD150518A000000	R930058427
OD150518D000000	R930058344
OD150518DP00000	R930059757
OD150718A000000	R930058338
OD150718D000000	R930058336
OD150718DP00000	R930058529
OD150118E000000	R930060958
OD150518E000000	R930060966
OD150718E000000	R930060973
OD153118A000000	R930058334

Type	Material number
OD153118D000000	R930058898
OD153118E000000	R930065030
OD150518A800000	R930063229
OD150318A000000	R930062828
OD150918A000000	R930064361
OD153118DP00000	R930066685
OD150518D800000	R930063959
OD150318D000000	R930065238
OD150918D000000	R930066189
OD150318A800000	R930065856
OD150518A800000	R930063229
OD153118A800000	R930066547

Characteristic curves

All Versions - Admissible supply voltage Vs. Ambient temperature at 100% duty cycle

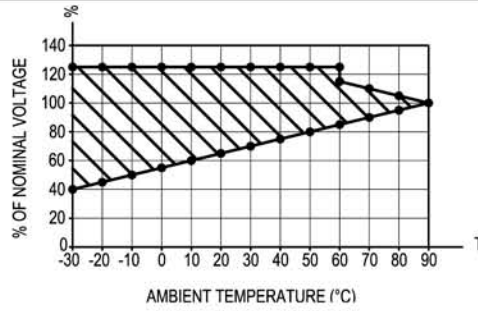

Versions 01, 05, 07 Version 05 with extra spring

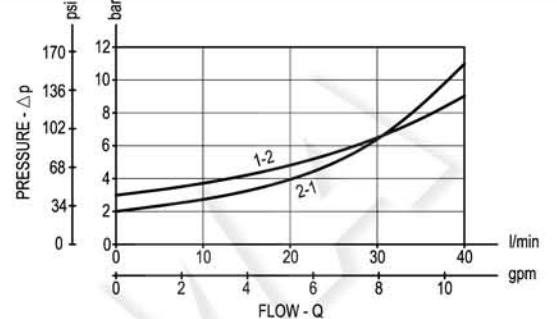
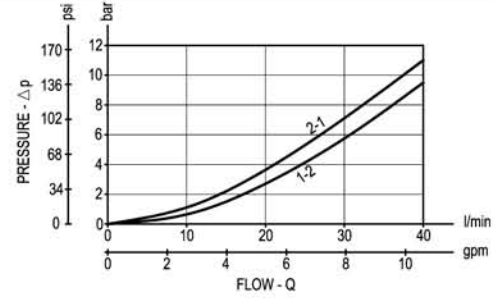

Version 31 Version 31 with extra spring

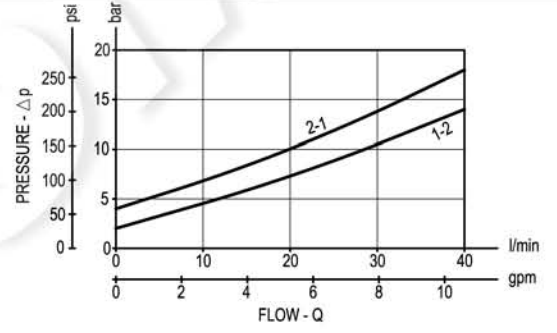
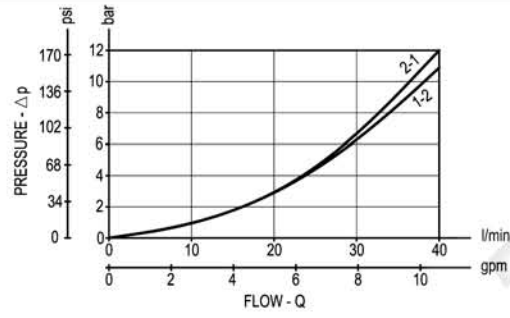

Versions 03, 09 Version 03 with extra spring

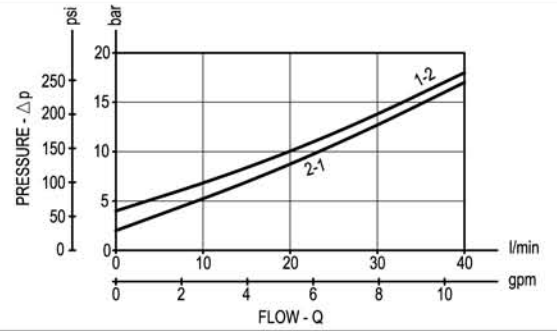
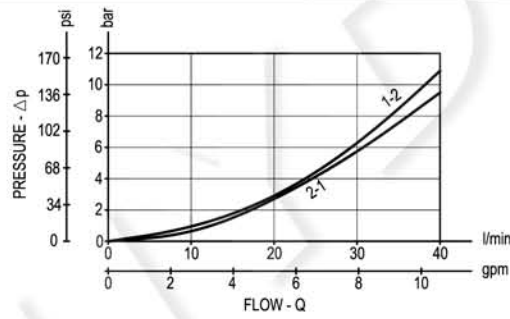

Dimensions

Solenoid operated valves, poppet 2-way normally closed

