

Flow control valves

Pressure compensated adjustable flow regulator with reverse flow check

VCD-RU-38

OE.22.01.04.02

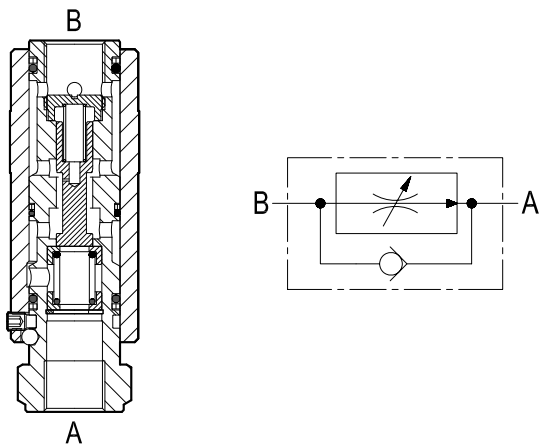

Description

This line mounted pressure compensated flow regulator limits the flow from B to A to the preset value, regardless of inlet pressure at B port. The internal metering restriction can be enlarged or reduced by rotating the external cylindrical sleeve in the (+) or (-) direction in order to increase or decrease the regulated flow. Once the desired adjustment is achieved, the sleeve can be locked in position by tightening external locking screw (with a 2,5 mm Allen key) in order to prevent inadvertent changes of motion due to line vibrations. Minor leakage "B-A" can be expected with valve fully closed. Free reverse flow "A-B" is always allowed when pressure at A rises above the spring bias pressure and the poppet is pushed from the seat: cracking pressure is 1 bar.

Performance

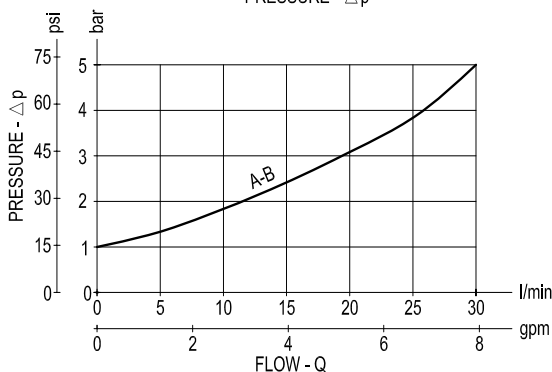
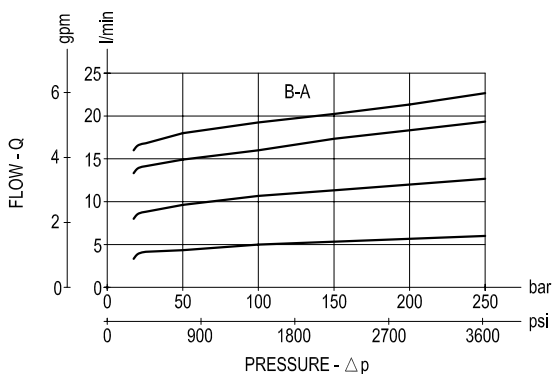

Δp curves vs. flow in "A-B" free flow direction.

Technical data

Pressure P max bar (psi)	Flow Q max l/min (gpm)	Weight kg (lbs)
210 (3000)	1-18 (0.26-4.76)	0.33 (0.73)

Steel body, zinc plated

Advantages

- Very compact design and inline mounting for space saving.
- Mounting position is unrestricted.

Dimensions

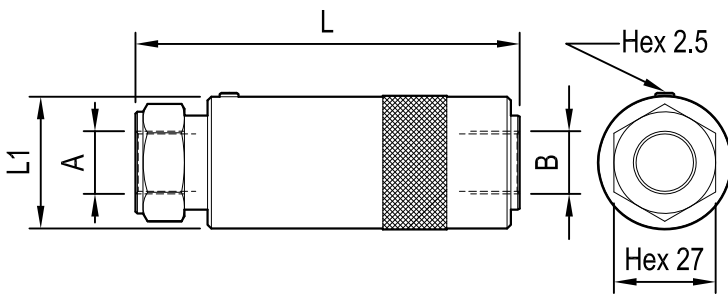

Ports size / Dimensions

Ports A-B	L mm (inches)	L1 mm (inches)
G 3/8	102 (4.02)	35 (1.38)

Applications

The VCD-RU is a normally open, two ports, restrictive type flow regulator, with incorporated check valve for free reverse flow. Typical applications are the control of the maximum speed of an actuator (cylinder or motor), which is achieved by regulating the maximum flow A into or out from the actuator (meter-IN, or meter-OUT). The maximum flow, and consequently the maximum actuator speed, will vary slightly with changes in fluid viscosity, but will be largely independent from the load and from the working pressure. If the valve is used to control the flow from a constant flow line, only the regulated flow will pass through the valve; any excess flow will normally be forced out of the line and delivered to tank through the system relief valve.

Ordering code

OE.22.01.04.02

Pressure compensated adjustable flow regulator with reverse flow check

Type	Material number	Type	Material number	Type	Material number
OE220104020000	R934001680				